

# SURGICAL INSTRUMENTS

Diagnostic  
Laryngoscope  
Scissors  
Dissecting  
Hamostats Forceps  
Needle Holders  
Retractors  
Cordio Vascular  
Electro Surgical  
Hollow Ware



**Manufacturers and Exporters of Surgical,  
Dental and Precision Tools.**



## S.S. Surgimed

World Class Instruments Since 1980

**Address:**

Small Industrial Estate, kacha shahabpura,  
Sialkot, Pakistan.

**Phone:**+92-524-263953

**Whatsapp:**+92-334-00-00-336

**Email:**info@ssurgimed.com

**Web :**www.sssurgimed.com

**S.S.Surgimed** dates back to three decades when our fore-father Sheikh Qamar Din, established a local surgical manufacturing unit in 1980. After gaining rich experience & understanding about the Surgical Instruments, he established an Export Oriented Company in 1985.

In early 2000s, his son Mr. Sheikh Sohail Qamar took over. This is when an era of international recognition and growth started for the company in real terms. He invested heavily into the future of the company i.e. utilizing modern equipment and techniques, streamlining the manufacturing processes to gain maximum efficiency. But above all the well-groomed craftsmen and women who are our real success in this field.

He envisioned a company which goes beyond customers` expectations.

As of today, **S.S.SURGIMED** is in one of the leading manufacturer and supplier of high-quality and single-use General Surgery Instruments, Dental Instruments and Hand Tools which include specialized tweezers for Electronics assembly, Watch-making and Jewelry Assembly Lines etc. End to end manufacturing processes for these instruments are established in house which helps us to ensure consistent quality, timely deliveries and R&D for new products.

Thanks to our vigorous R&D department S.S.SURGIMED specializes in designing, prototyping, manufacturing, marketing, and distributing new products for surgeries and hand tools industry. Full instrument repair and refurbishing are performed at our facility for all original products and other expensive surgical instruments & tools.

We are a quality-conscious organization and lay a lot of emphasis upon the quality of the products offered by us. To guarantee the quality of each and every product leaving our factory premises, we have designed a very strict quality policy. We continue to manufacture all of our products in-house, to the highest quality standards, for surgeons worldwide. Our credibility and authenticity are evident from the fact that we have acquired **ISO 9001:2015**, **ISO 13485:2016** and **CE certification**.

We appreciate all our business partners who have supported us for decades and welcome new customers to benefit from our long line of skilled labor and instruments.

with utmost pleasure,

Jahanzeb Shams – Managing Partner  
**S.S.SURGIMED**





S.S.Surgimed

World Class Instruments Since 1980

# SURGICAL INSTRUMENTS

DIAGNOSTIC



001

DIAGNOSTIC SET  
( ENT COMPLETE)

S.S.Surgimed

World Class Instruments Since 1980



002

Otoscope Set Box Pack

## DIAGNOSTIC



**003**  
**Fiber Optic Miller**  
**Laryngoscope Set**

# S.S.Surgimed

World Class Instruments Since 1980



**004**  
**Macintosh**  
**Laryngoscope Set**

## ●●● Surgical Handles

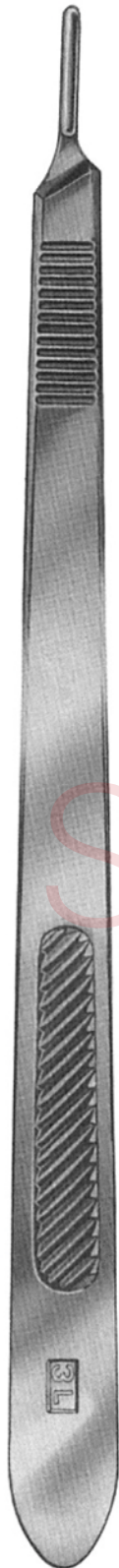

No.3L  
102-0001

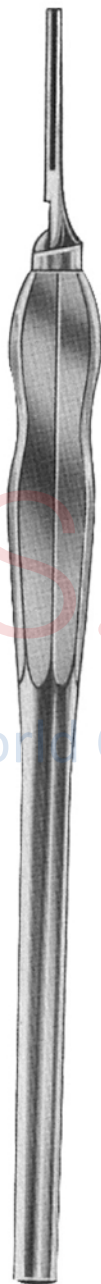

ERGONOMIC  
102-0002



No.7  
102-0003



102-0004



102-0005

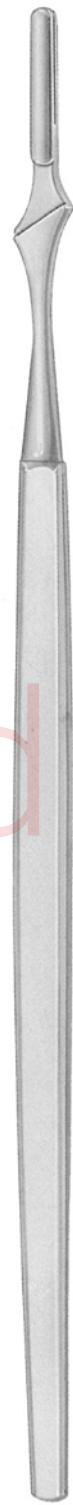

102-0006



S.S. Surgimed

World Class Instruments Since 1980

# SURGICAL INSTRUMENTS

Surgical Handles ●●●

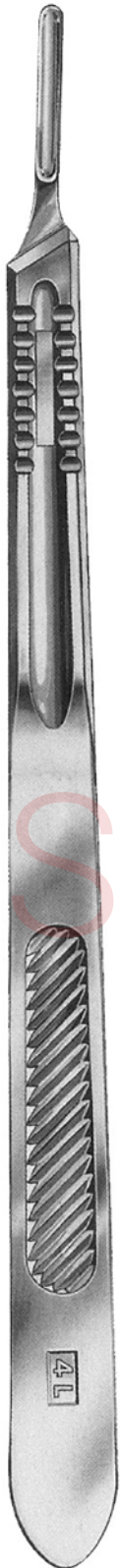

No. 4L  
102-0007



No. 4  
102-0008



No. 10  
102-0009



No. 9  
102-0010

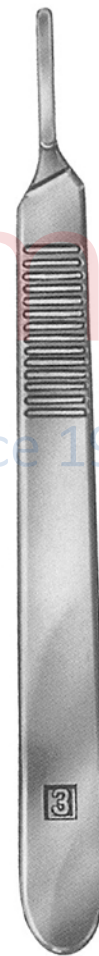

No. 3  
102-0011



**BARRON**  
102-0012  
For "B.P." type blades  
for use with No's  
10, 11, 12 & 15 blades  
135mm (5.1/4")



● ● ● Scissors

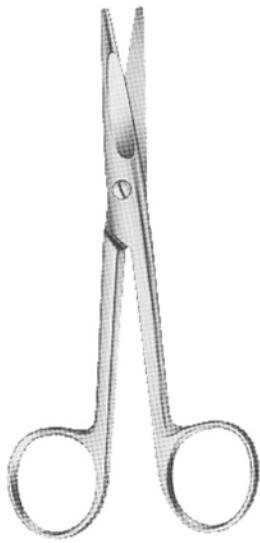

**MAYO**  
Straight, bevelled blades



**103-0001**  
140 mm  
(5.1/2")

**103-0003**  
190 mm  
(7.1/2")

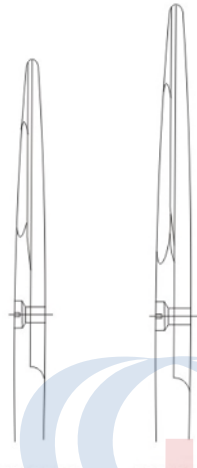

**103-0002**  
170 mm  
(6.3/4")

**103-0004**  
215mm  
(8.1/2")



**103-0005**  
140 mm  
(5.1/2")

**103-0007**  
190 mm  
(7.1/2")



**103-0006**  
170 mm  
(6.3/4")

**103-0008**  
215mm  
(8.1/2")

Curved on flat, bevelled blades

# S.S. Surgimed

World Class Instruments Since 1980

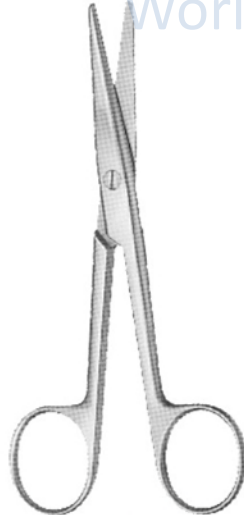

**MAYO**  
Round Blades

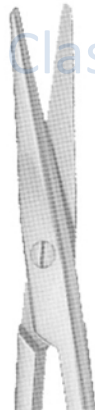

**103-0009**  
170 mm  
(6.3/4")

200mm  
(8")  
Straight

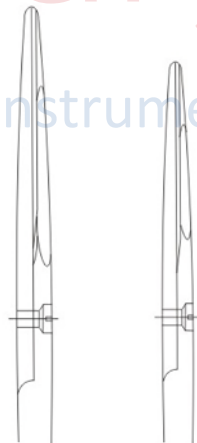

**103-0010**  
140mm  
(5.1/2")

150 mm  
(6")  
Straight



**MAYO**  
Round Blades



**103-0011**  
170 mm  
(6.3/4")

200mm  
(8")  
Curved on  
flat



**103-0012**  
140mm  
(5.1/2")

150 mm  
(6")  
Curved on  
flat



S.S.Surgimed

World Class Instruments Since 1980

# SURGICAL INSTRUMENTS

Scissors ●●●

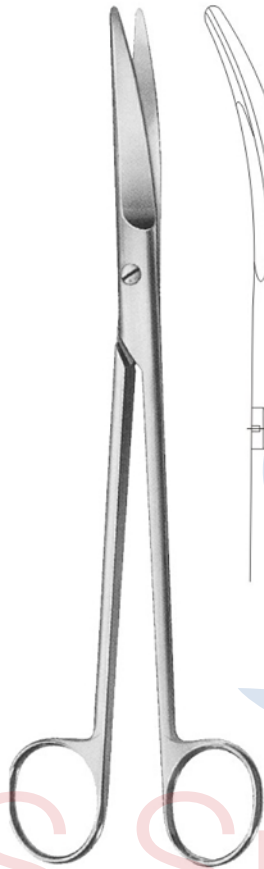

**MAYO HARRINGTON**  
**103-0013**  
225mm (9")  
Curved on flat , blunt points

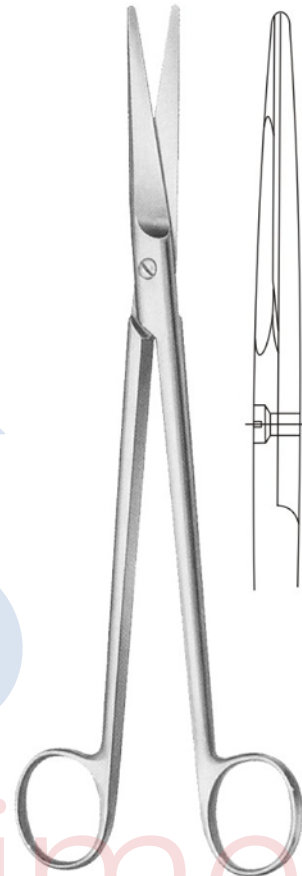

**MAYO HARRINGTON**  
**103-0014**  
225mm (9")  
Straight, blunt points

World Class Instruments Since 1980

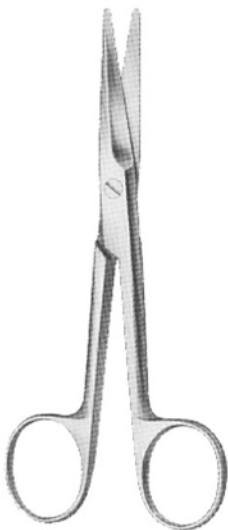

**MAYO (STILLE)**



**103-0015**  
170 mm  
(6.3/4")  
Straight



**103-0016**  
150 mm  
(6")  
Straight



**103-0017**  
170 mm  
(6.3/4")  
Curved on  
flate



**103-0018**  
150 mm  
(6")  
Curved on  
flate

● ● ● Scissors



**METZENBAUM**

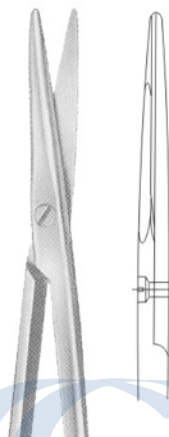

**METZENBAUM**

Straight, blunt points

103-0019 115mm (4.1/2")

103-0020 145mm (5.3/4")

103-0021 180mm (7")

103-0022 200mm (8")

**METZENBAUM (Nelson)**

Straight

103-0023 230mm (9")

103-0024 250mm (10")



**METZENBAUM**

Curved on flat, blunt points

103-0025 115mm (4.1/2")

103-0026 145mm (5.3/4")

103-0027 180mm (7")

103-0028 200mm (8")

**METZENBAUM (Nelson)**

Curved on flat

103-0029 230mm (9")

103-0030 250mm (10")

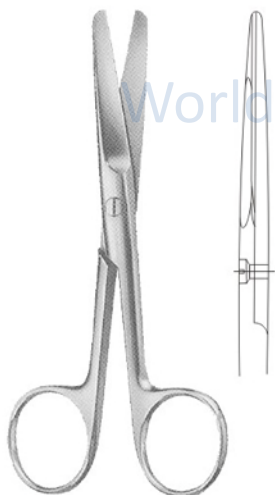

**DRESSING**

Straight, blunt / blunt points

103-0031 125mm (5")

103-0032 145mm (5.3/4")

103-0033 150mm (6")

103-0034 180mm (7")

103-0035 200mm (8")

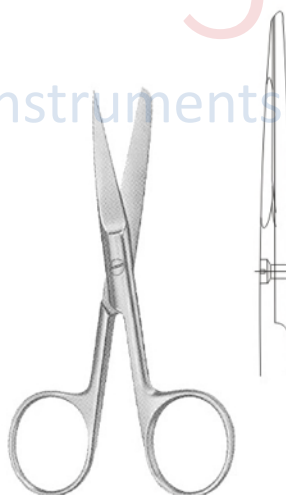

**DRESSING**

Straight, sharp / blunt points

103-0036 125mm (5")

103-0037 145mm (5.3/4")

103-0038 150mm (6")

103-0039 180mm (7")

103-0040 200mm (8")

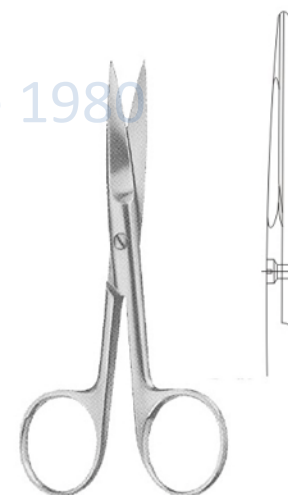

**DRESSING**

Straight, sharp / Sharp points

103-0041 125mm (5")

103-0042 145mm (5.3/4")

103-0043 150mm (6")

103-0044 180mm (7")

103-0045 200mm (8")



S.S. Surgimed

World Class Instruments Since 1980

# SURGICAL INSTRUMENTS

Scissors ●●●



**CRAFOORD**  
103-0046 305mm (12")  
Straight

**LLOYD DAVIS RECTAL**  
blunt points, flat blades  
103-0047 255mm (10")  
Curved on flat  
103-0048 255mm (10")  
Straight

**UTERINE**  
103-0049 230mm (9")  
Straight. blunt points

**UTERINE**  
Curved on flat, blunt points  
103-0050 200mm (8")  
103-0051 230mm (9")





● ● ● Scissors



**BRAUN STADTLER**  
EPISIOTOMY Angled blades  
103-0052 145mm (5.3/4")  
103-0053 200mm (8")



**AMERICAN PATTERN**  
UMBILICAL Angled blades  
103-0054 100mm (4")



**HEGEMANN'S DELICATE**  
190mm (7.1/2")



103-0055  
25°



103-0056  
45°



103-0057  
60°

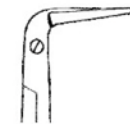

103-0058  
90°



103-0059  
120°

# S.S. Surgimed

World Class Instruments Since 1980

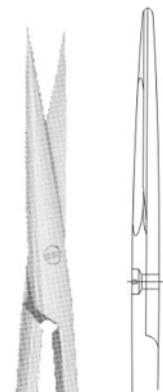

**KILNER**  
103-0060 110mm (4.1/2")  
Straight, sharp points  
103-0061 110mm (4.1/2")  
Curved on flat, blunt points

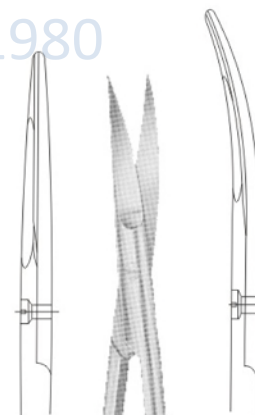
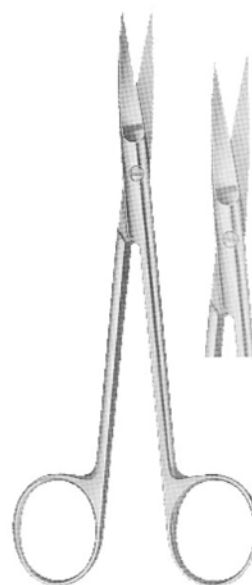

**AUFRICHT**  
150mm (6") Lightweight  
103-0062 Straight  
103-0063 Curved on flat



S.S. Surgimed

World Class Instruments Since 1980

# SURGICAL INSTRUMENTS

## Delicate Scissors ●●●



**103-0064**  
Straight  
**103-0065**  
Curved on flat

**IRIS**  
110mm (4.1/2")  
sharp points

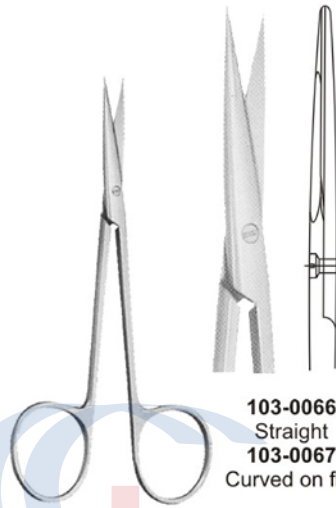

**103-0066**  
Straight  
**103-0067**  
Curved on flat

**IRIS**  
110mm (4.1/2")  
Round blades,  
sharp points

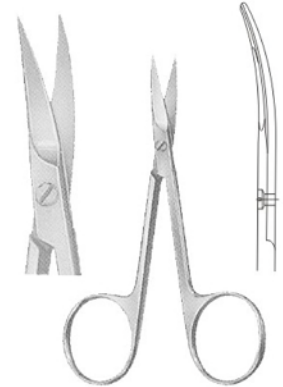

**IRIS**  
**103-0068** 90mm (3.1/2")  
Curved on flat, lightweight  
sharp points

# S.S. Surgimed

World Class Instruments Since 1980



**103-0069** 110mm (4.1/2")  
Straight  
**103-0070** 110mm (4.1/2")  
Curved on flat

**STRABISMUS**



**HEYMANN  
TURBINECTOMY**  
**103-0071** 185mm (7.1/4")  
Angled shanks  
blunt points



●●● Delicate & Oral Scissors



**STEVENS TENOTOMY**  
110 mm (4.1/4")

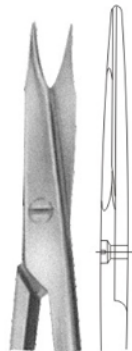

**103-0072**  
straight,  
sharp points

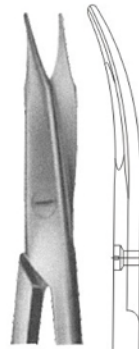

**103-0073**  
Curved on flat  
sharp points

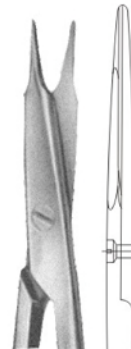

**103-0074**  
straight,  
blunt points

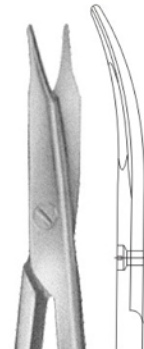

**103-0075**  
Curved on flat  
blunt points

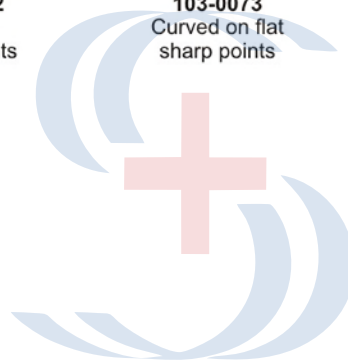

S.S. Surgimed

World Class Instruments Since 1980

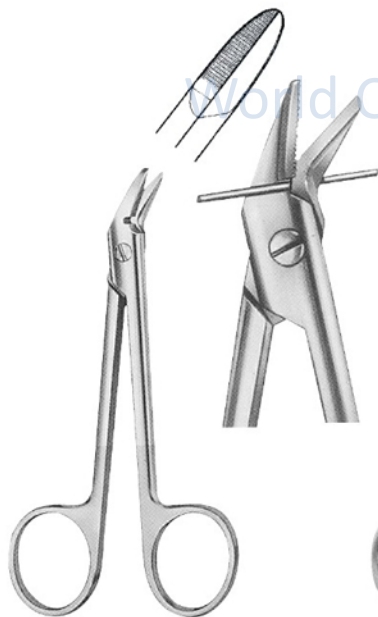

**SCHUKNECHT WIRE CUTTING**  
**103-0076** 125mm (5")



**WOODS TONSIL**  
190mm (7.1/2")



**103-0077**  
Curved on flat  
sharpened  
outer edge, blunt



**WHEELER TONSIL**  
**103-0078** 200mm (8")  
Curved on flat

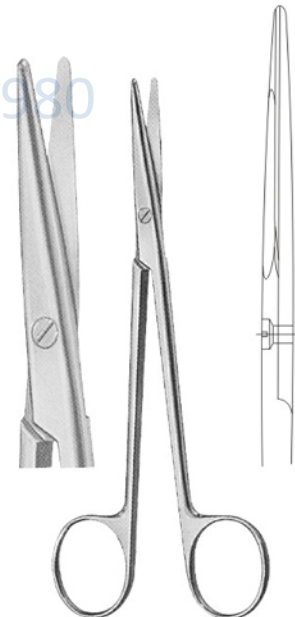

**WILSON TONSIL**  
**103-0079** 180mm (7")  
Straight



S.S. Surgimed

World Class Instruments Since 1980

# SURGICAL INSTRUMENTS

## Scissors ●●●

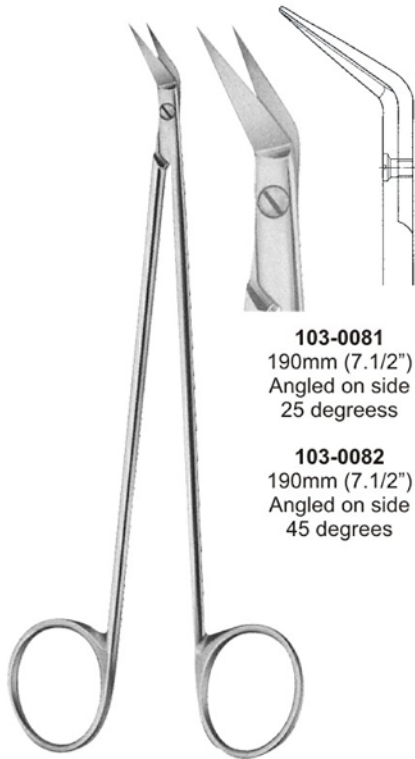

**103-0081**  
190mm (7.1/2")  
Angled on side  
25 degrees

**103-0082**  
190mm (7.1/2")  
Angled on side  
45 degrees

**POTTS**  
**103-0080** 190mm (7.1/2")  
Angled on flat 45 degrees

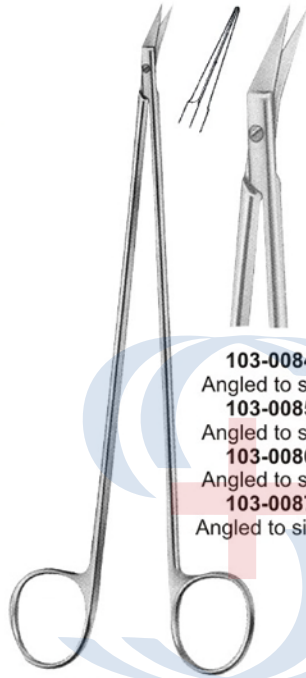

**103-0084** 175mm (7")  
Angled to side, 45 degrees  
**103-0085** 175mm (7")  
Angled to side, 60 degrees  
**103-0086** 175mm (7")  
Angled to side, 90 degrees  
**103-0087** 175mm (7")  
Angled to side, 125 degrees

**HEDGEMAN (DIETRICH)**  
**103-0083** 175mm (7")  
Angled to side, 25 degrees

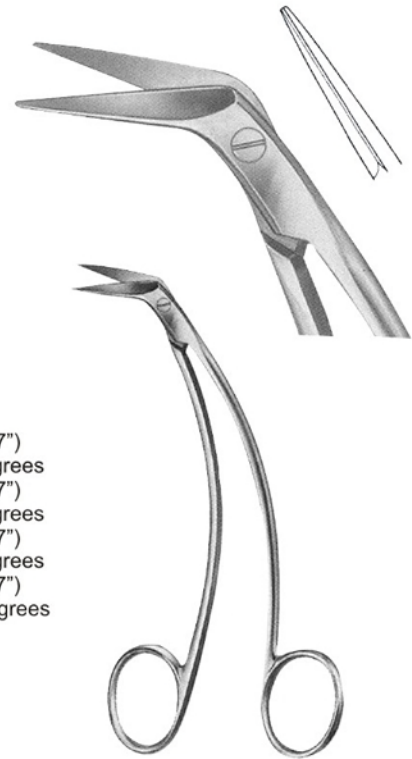

**FAVALORO**  
**103-0088** 150mm (6")  
Shanks curved, blades angled to side

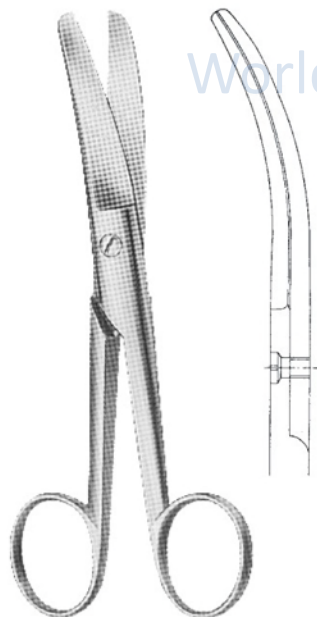

**DOYEN ABDOMINAL**  
**103-0089** 180mm (7")  
Curved, blunt points

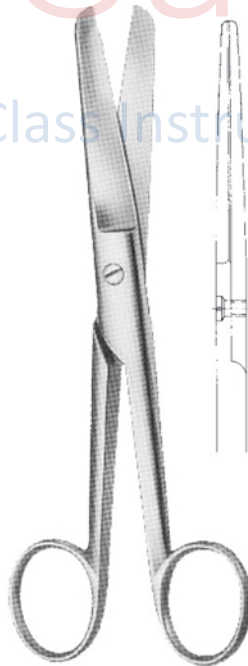

**DOYEN ABDOMINAL**  
**103-0090** 180mm (7")  
Straight, blunt points

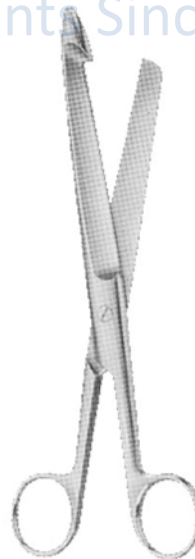

**DOYEN ABDOMINAL**  
**103-0091** 210mm (8.1/4")  
One blade with hook end



**COUNTER SCISSORS**  
**103-0092** 210mm (8.1/4")



● ● ● Scissors

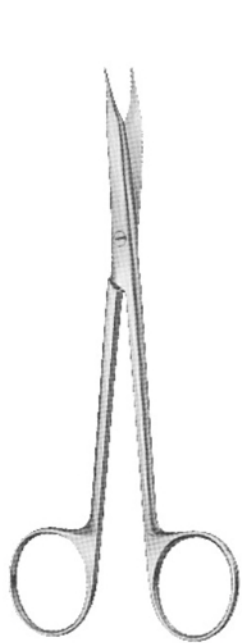

**REYNOLDS**  
Curved on flat, tapered points

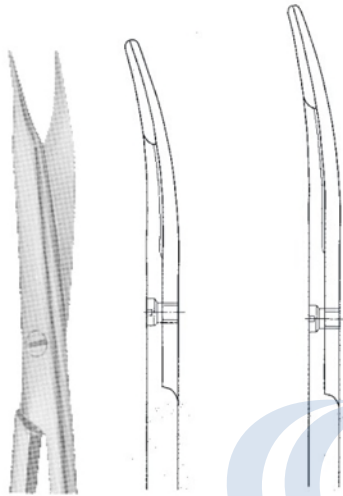

103-0093 145mm (5.3/4")  
103-0094 180mm (7")

103-0095 115mm (4.1/2")  
103-0096 140mm (5.1/2")  
103-0097 180mm (7")  
103-0098 200mm (8")  
103-0099 235mm (9.1/4")

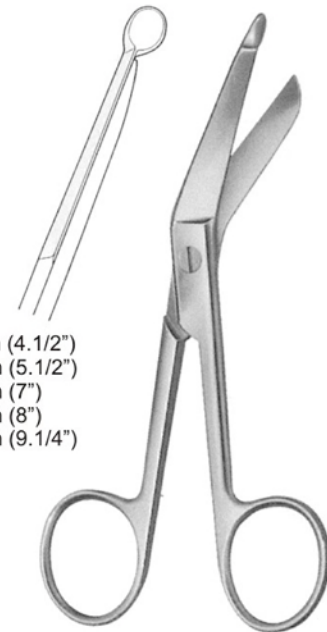

**LISTER BANDAGEz**

S.S. Surgimed

World Class Instruments Since 1980



**SCHUMACHER UMBILICAL**  
103-0100 155mm (6")

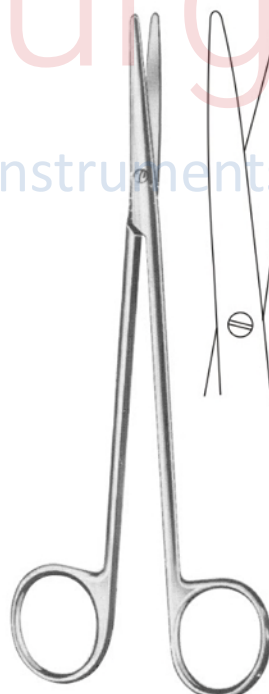

**MCINDOE SCISSORS**  
103-0101 180mm (7")  
Straight

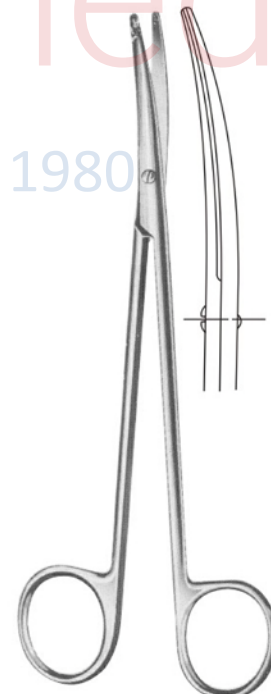

**MCINDOE SCISSORS**  
103-0102 180mm (7")  
Curved



S.S. Surgimed

World Class Instruments Since 1980

# SURGICAL INSTRUMENTS

## Serrated Dissecting Forceps ●●●



**CANADIAN  
Straight**  
104-0001 130mm (5.1/8")  
104-0002 150mm (6")



**DISSECTING  
FORCEPS**  
Turn over end  
104-0003 125mm (5")  
104-0004 150mm (6")  
104-0005 180mm (7")  
104-0006 200mm (8")  
104-0007 250mm (10")



**DISSECTING  
FORCEPS**  
Block end  
104-0008 125mm (5")  
104-0009 150mm (6")  
104-0010 180mm (7")  
104-0011 200mm (8")  
104-0012 250mm (10")



**DISSECTING  
FORCEPS**

104-0013  
150mm  
(6")

104-0014  
180mm  
(7")

104-0015  
200mm  
(8")

S.S. Surgimed

World Class Instruments Since 1980



104-0016  
115mm  
(4.1/2")



104-0017  
130mm  
(5.1/8")



104-0021  
115mm  
(4.1/2")



104-0022  
130mm  
(5.1/8")



104-0023  
150mm  
(6")



104-0024  
160mm  
(6.1/4")



**DISSECTING  
FORCEPS**



104-0018  
145mm  
(5.3/4")



104-0019  
160mm  
(6.1/4")



104-0020  
305mm  
(12")



**DISSECTING  
FORCEPS**  
Round Points



104-0025  
180mm  
(7")



104-0026  
200mm  
(8")



104-0027  
250mm  
(10")



104-0028  
300mm  
(12")

## ●●● Serrated Dissecting Forceps



**RAMSEY**  
104-0029  
180mm (7")

**BONNEY**  
104-0030  
180mm (7")

**BICKFORD**  
104-0031  
225mm (9")

**MAINGOT INTESTINAL**  
Fenestrated Grip  
104-0032  
280mm (11")

**ST MARKS**  
104-0033  
290mm (11.1/2")

**EMMET**  
104-0034  
200mm (8")



S.S. Surgimed

World Class Instruments Since 1980

# SURGICAL INSTRUMENTS

## Delicate Dissecting Forceps ●●●

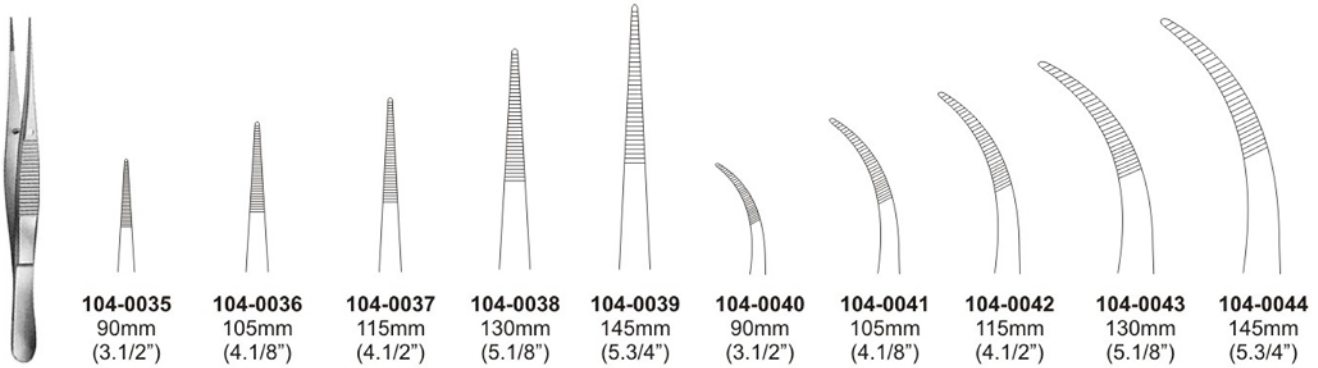

S.S. Surgimed  
World Class Instruments Since 1980

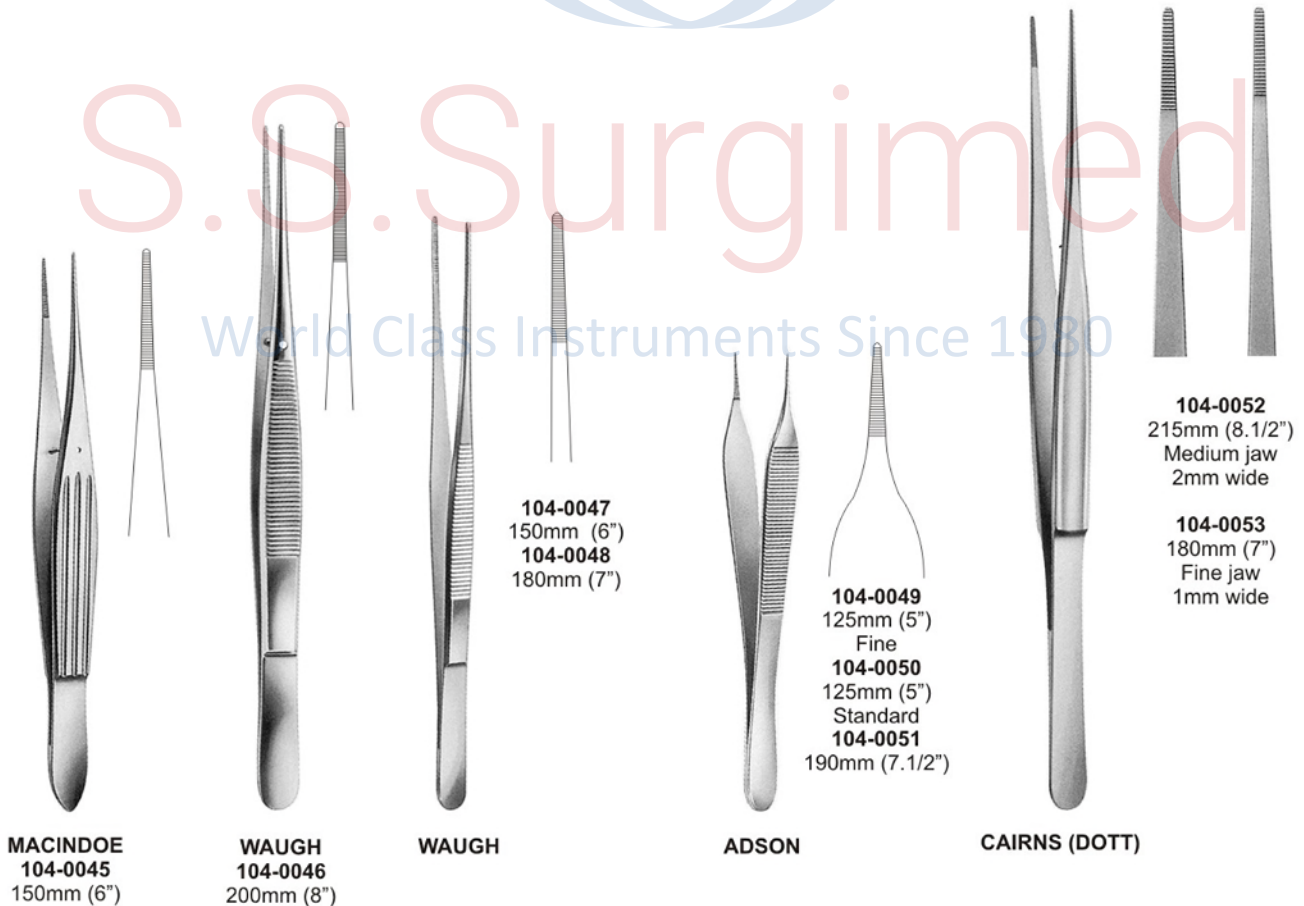





## ●●● Delicate Dissecting Forceps

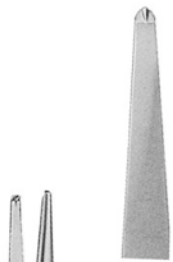

**104-0054**  
125mm (5")  
**104-0055**  
150mm (6")  
**104-0056**  
180mm (7")  
**104-0057**  
200mm (8")  
**104-0058**  
250mm (10")

**TREVES**  
1 x 2 teeth



**LANE**  
1 x 2 teeth



**104-0059**  
125 mm (5")  
**104-0060**  
145mm (5.3/4")  
**104-0061**  
180mm (7")  
**LANE**  
2 x 3 teeth  
**104-0062**  
145mm (5.3/4")  
**104-0063**  
180mm (7")



**DISSECTING FORCEPS**

**104-0064**  
150mm (6")  
2 x 3 teeth  
**104-0065**  
150mm (6")  
3 x 4 teeth



**WAUGH**  
1 x 2 teeth



**104-0066**  
200mm (8")  
**104-0067**  
180mm (7")  
**104-0068**  
150mm (6")

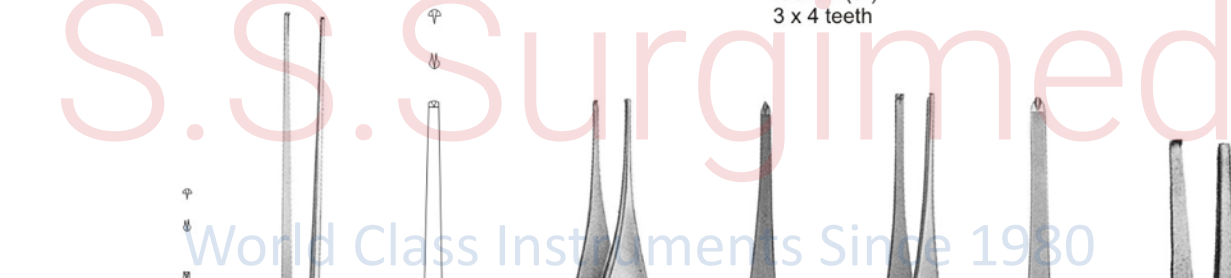

**ADSON**  
1 X 2 teeth



**104-0069**  
125mm (5") Fine  
**104-0070**  
125mm (5") Standard  
**104-0071**  
190mm (7.1/2")



**ADSON-BROWN**  
Bayonet  
1 x 2 teeth

**104-0072**  
190mm (7.1/2")



**JEFFERSON**  
1 x 2 teeth



**104-0073**  
180mm (7")



**ADSON-BROWN**  
7 x 7 teeth



**104-0074**  
125mm (5")



**PENNYBACKER**  
3 x 4 teeth  
**104-0075**  
160mm (6.1/2")



S.S. Surgimed

World Class Instruments Since 1980

# SURGICAL INSTRUMENTS

## Toothed Dissecting Forceps ●●●

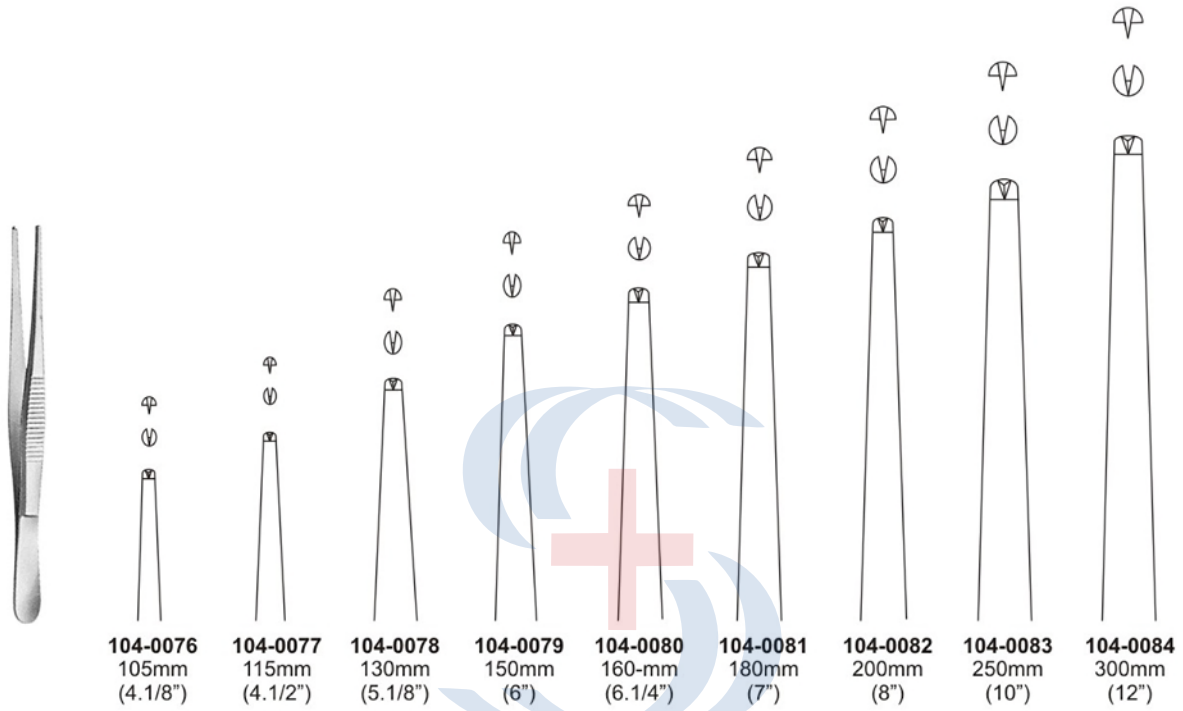

# S.S. Surgimed

**DISSECTING FORCEPS**  
1 x 2 teeth

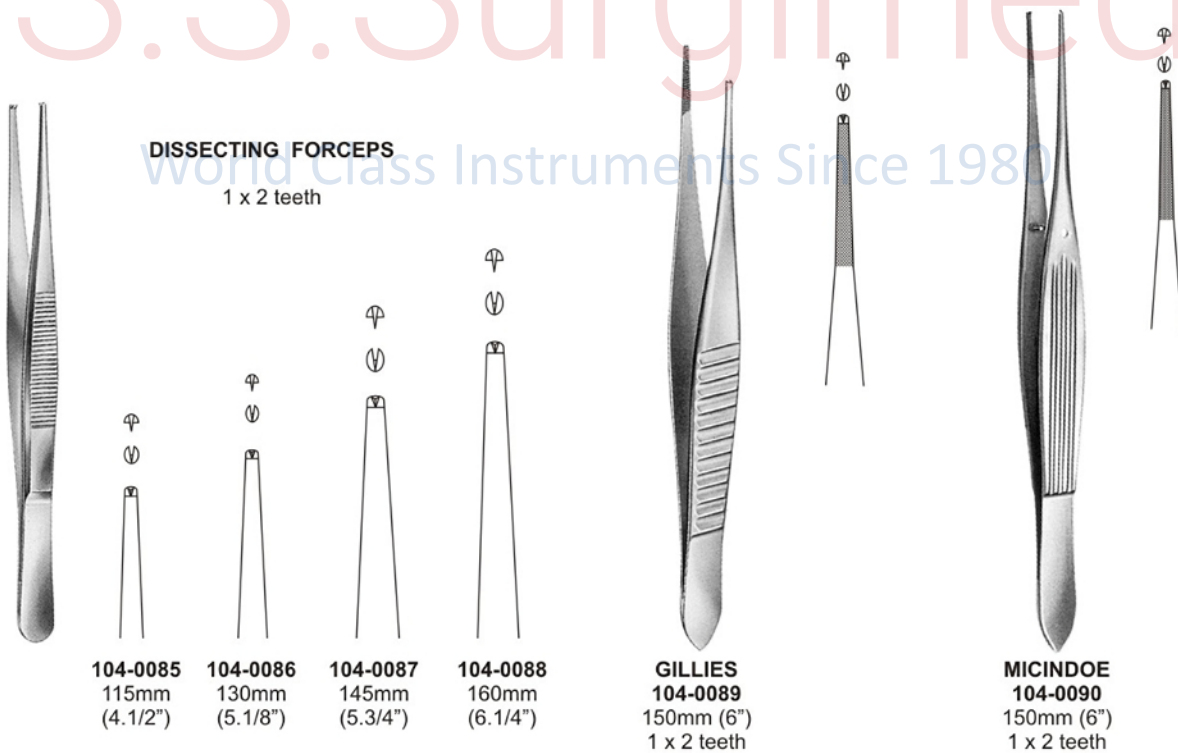



## ●●● Toothed Dissecting Forceps



104-0091

**SILCOCK**  
1 x 2 teeth

104-0092  
100mm (4")

104-0093  
110mm (4.3/8")



104-0094



104-0095

**FINE**  
1 x 2 teeth

104-0096  
100mm (4")

104-0097  
100mm (4")



104-0098



104-0099



104-0100

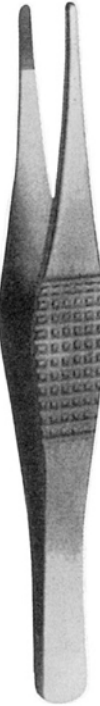

**RAMSEY**  
180mm (7")



**BONNEY**  
1 x 2 teeth

104-0101  
180mm (7")

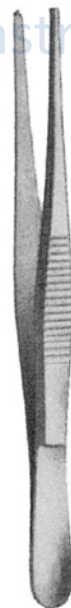

**BICKFORD**  
1 x 2 teeth

104-0102  
225mm (9")



**CANADIAN**  
2 x 3 teeth

104-0103  
140mm (5.1/2")

104-0104  
150mm (6")



S.S. Surgimed

World Class Instruments Since 1980

# SURGICAL INSTRUMENTS

## Toothed Dissecting Forceps ●●●

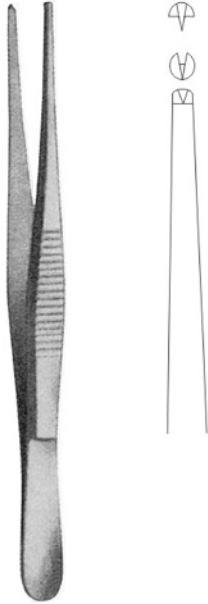

**ST MARKS**  
1 X 2 teeth

**104-0105**  
290mm (11.1/2")



**OFFICER**  
4 x 5 teeth

**104-0106**  
150mm (6")



**JACKSON  
BURROWS**  
1 x 2 teeth

**104-0107**  
140mm (5.1/2")



**MUSTARDE**  
Combined, double hooked jaw

**104-0108**  
150mm (6")



**RUSSIAN**  
With circular jaw

**104-0109**  
150mm (6")

**104-0110**  
200mm (8")

**104-0111**  
250mm (10")



**NELSON LUNG  
ADHESION**

**104-0112**  
230mm (9")

S.S. Surgimed

World Class Instruments Since 1980



## ●●● Splinter Forceps



**104-0113  
ARTHURE**  
140mm (5.1/2")



**104-0114  
FEILCHENFEL**  
70mm (3")  
90mm (3.1/2")  
115mm (4.1/2")



**104-0115  
HUNTER**  
105mm (4.1/8")



**DENIS BROWNE  
104-0116**  
190mm (7.1/2")



**MICRO SOFT TOUCH RING TIP**  
**104-0117**  
150mm (6")  
**104-0118**  
185mm (7.1/4")  
**104-0119**  
210mm (8.1/4")  
**104-0120**  
230mm (9")  
**104-0121**  
250mm (10")



**TROELTSCH (Wilde)**  
**104-0122**  
110mm (4.1/2")

**TROELTSCH (Wilde)**  
**104-0123**  
120mm (4.3/4")  
1 x 2 teeth



**TUDICHUM**  
**104-0124**  
65mm (23.1/2")

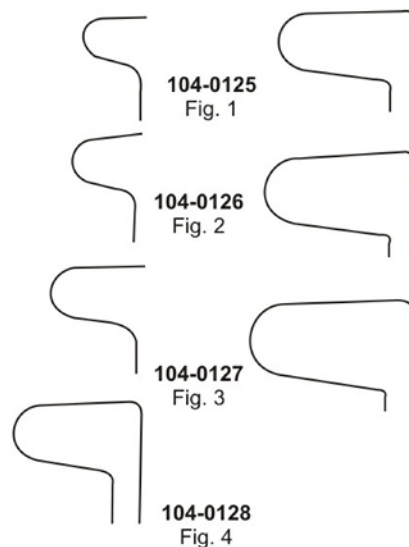

**104-0125**  
Fig. 1

**104-0126**  
Fig. 2

**104-0127**  
Fig. 3

**104-0128**  
Fig. 4





S.S. Surgimed

World Class Instruments Since 1980

# SURGICAL INSTRUMENTS

## Dissecting & Ligature Forceps ●●●



**LIGATURE FORCEPS**  
105-0001  
95mm (3.3/4")  
Straight, smooth jaw



**MICRO ADSON**  
105-0002  
140mm (5.1/2")

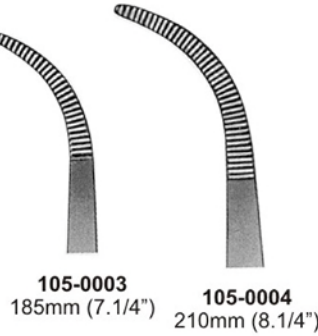

105-0003  
185mm (7.1/4")  
105-0004  
210mm (8.1/4")

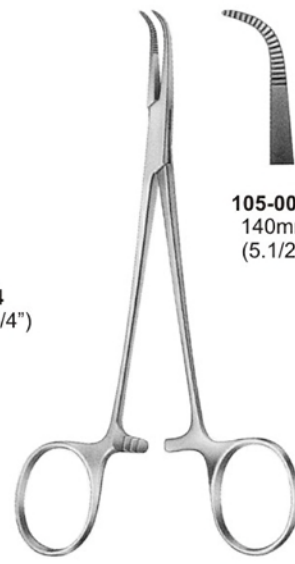

**BABY - ADSON**

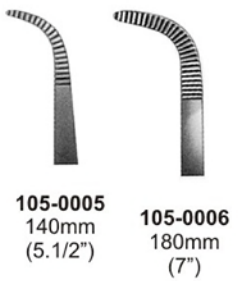

105-0005  
140mm (5.1/2")  
105-0006  
180mm (7")

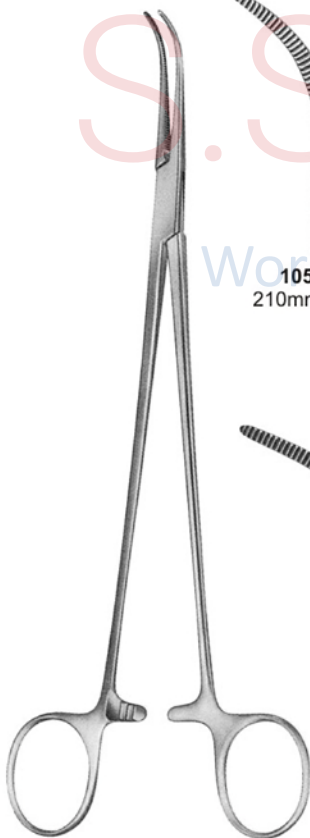

**FINE CURVED DISSECTING FORCEPS**

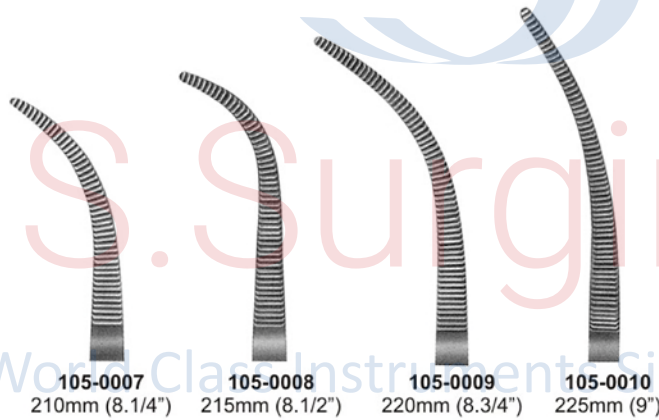

105-0007  
210mm (8.1/4")  
105-0008  
215mm (8.1/2")  
105-0009  
220mm (8.3/4")  
105-0010  
225mm (9")

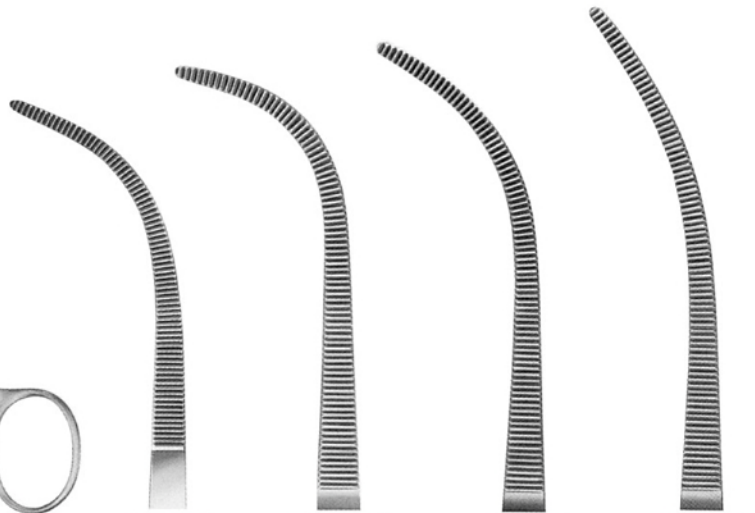

105-0011  
225mm (9")  
105-0012  
295mm (11.3/4")  
105-0013  
295mm (11.3/4")  
105-0014  
300mm (12")

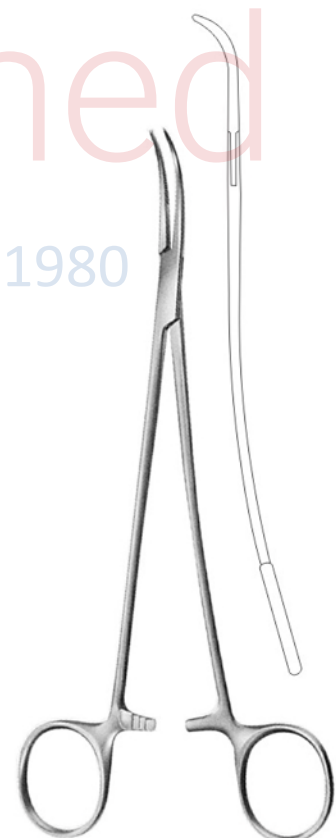

**S.SHAPED DELICATE**

## ●●● Dissecting & Ligature Forceps

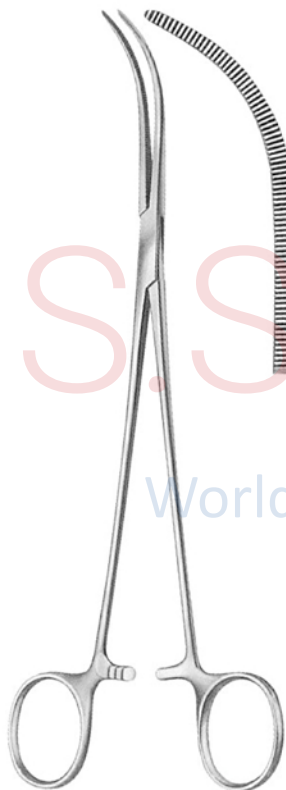

**MIXTER**  
105-0015  
200mm (8")

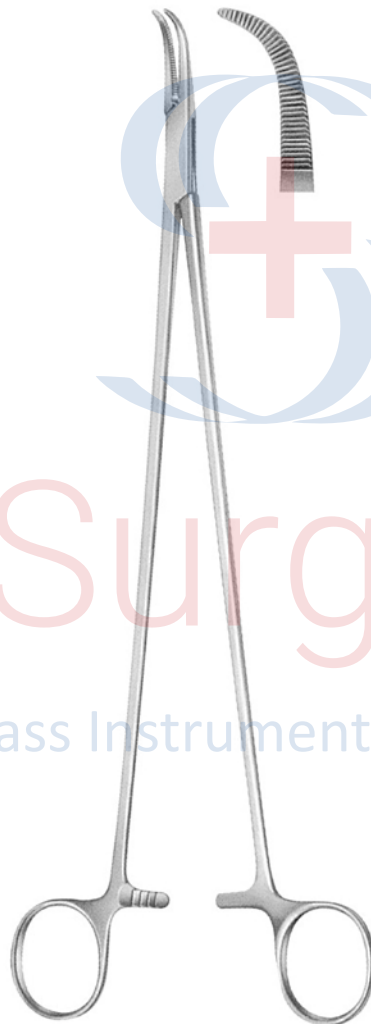

**LAWRENCE**  
105-0016  
270mm (10.3/4")



**105-0017**  
300mm  
(12")



**105-0018**  
290mm  
(11.1/2")



**LONG CURVED FORCEPS**



S.S. Surgimed

World Class Instruments Since 1980

# SURGICAL INSTRUMENTS

## Tissue Forceps ●●●



**RUTHERFORD MORISON**  
105-0019 150mm (6")  
6 x 7 teeth

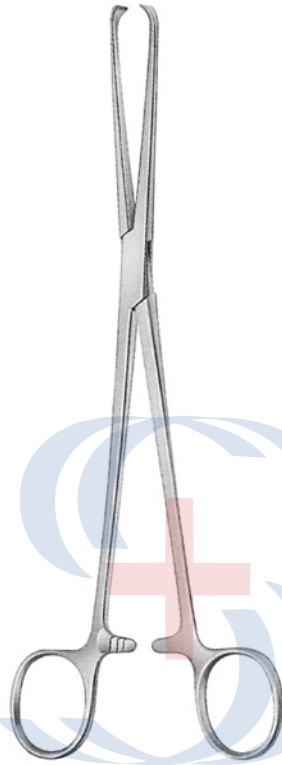

**STILES (ALLIS-THOMS)**  
105-0020 200mm (8")  
6 x 7 teeth

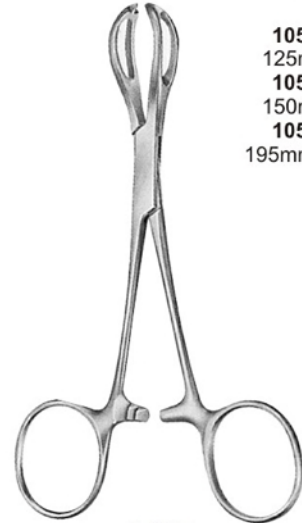

**LANE**  
1 x 2 teeth fenestrated



- 105-0021  
125mm (5")
- 105-0022  
150mm (6")
- 105-0023  
195mm (7.3/4")

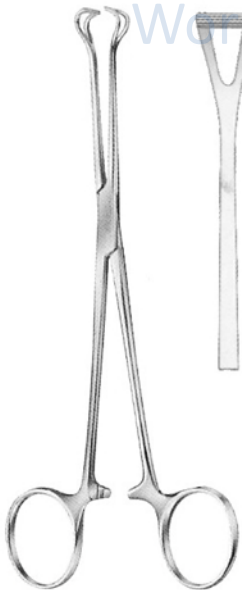

**BABCOCK**  
105-0024 165mm (6.1/2")

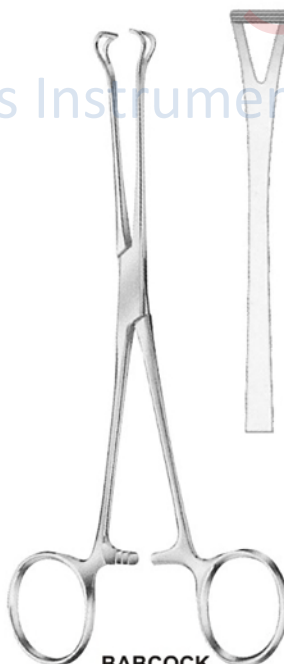

**BABCOCK**  
105-0025 200mm (8")  
Extra light

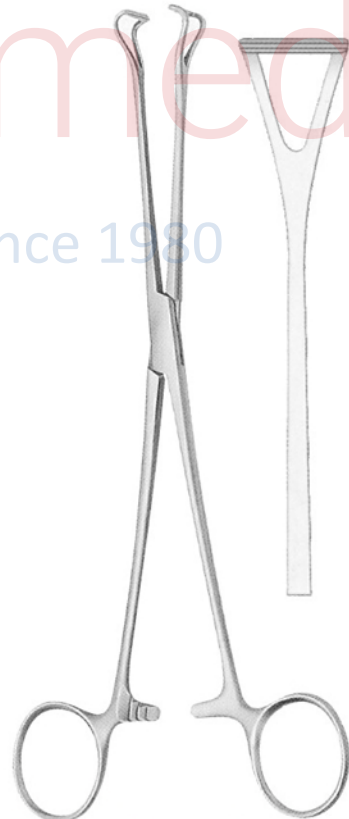

**BABCOCK**  
105-0026 230mm (9")

S.S. Surgimed  
World Class Instruments Since 1980

## ●●● Tissue Forceps



**ALLIS**  
150mm (6")  
105-0027 2 x 3 teeth  
105-0028 3 x 4 teeth  
105-0029 4 x 5 teeth  
105-0030 5 x 6 teeth  
105-0031 6 x 7 teeth



105-0032



105-0033

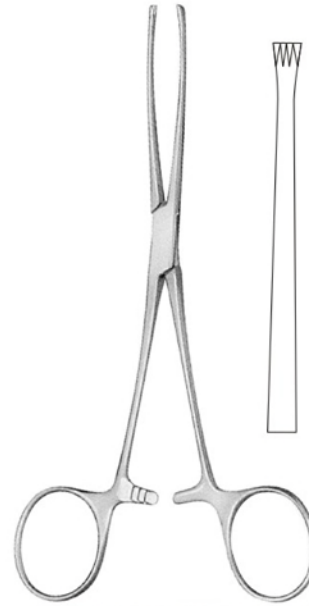

**AMERICAN PATTERN ALLIS**  
105-0034 150mm (6") 3 x 4 teeth



**JUD-ALLIS**  
105-0035 195mm (7.3/4")  
Light pattern, 3 x 4 teeth

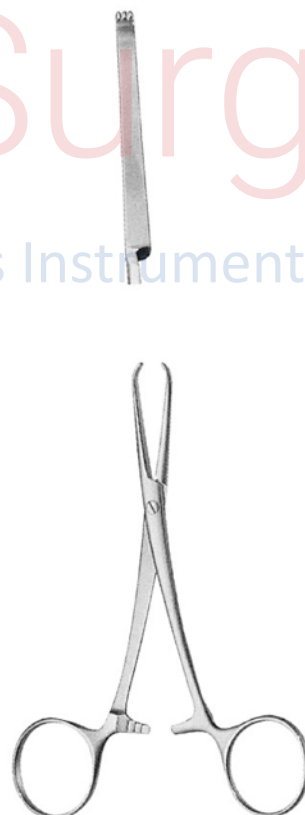

**CHAPUT (POIRIER)**  
105-0036 125mm (5") 2 x 3 teeth

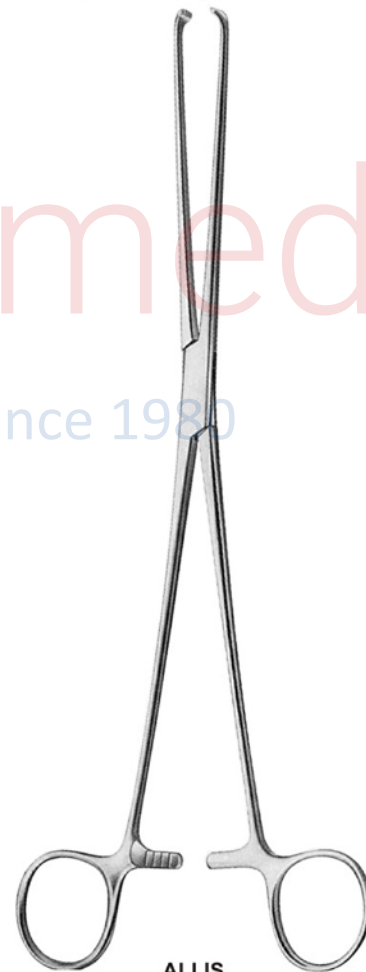

**ALLIS**  
105-0037 190mm (7.1/2")  
105-0038 255mm (10") 5 x 6 Teeth



S.S. Surgimed

World Class Instruments Since 1980

# SURGICAL INSTRUMENTS

Mouth Gags ●●●

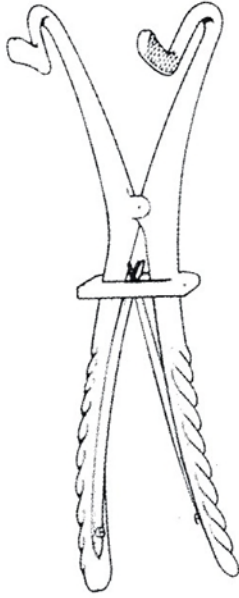

**FERGUSSON ACLAND**

**105-0039**  
170mm (6.3/4")

**105-0040**  
200mm (8")



**DOYEN (CHILD)**

**105-0041**  
120mm (4.3/4")



**FEATHERSTONE**

**105-0042**  
165mm (6.1/2")



**DOYEN (ADULT)**

**105-0043**  
140mm (5.1/2")

S.S. Surgimed

World Class Instruments Since 1980



## ●●● Tongue Depressors

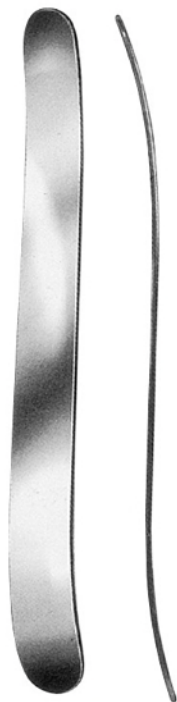

**105-0044**  
180mm (7")

**FLAT TONGUE DEPRESSOR**  
Double ended  
tapering 19mm + 23mm

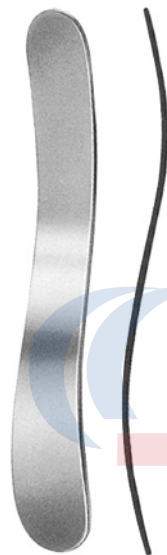

**105-0045**  
140mm (5.1/2")

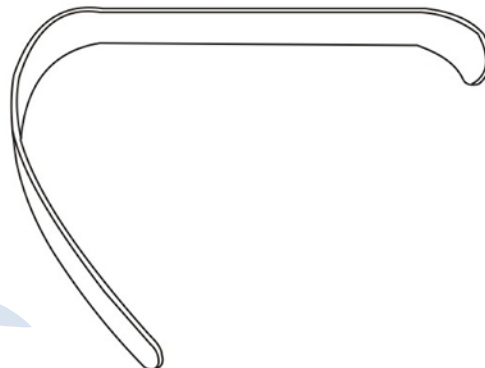

**LACK TONGUE DEPRESSOR**  
**105-0046** 13mm wide  
child  
**105-0047** 19mm wide  
Adolescent  
**105-0048** 22mm wide  
Adults

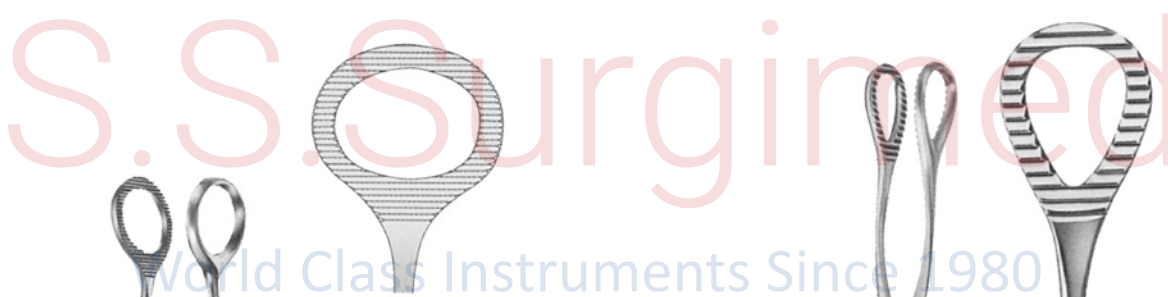

**COLLIN TONGUE FORCEPS**  
**105-0049** 170mm (6.3/4")  
**105-0050** 160mm (6.1/4")



**105-0051**



**105-0052**

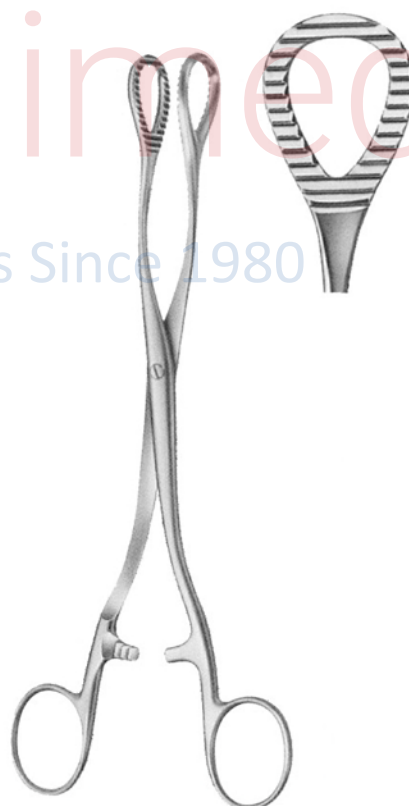

**HEYWOOD-SMITH TONGUE FORCEPS**  
**105-0053** 200mm (8")



S.S. Surgimed

World Class Instruments Since 1980

# SURGICAL INSTRUMENTS

## Towel Clamps ●●●

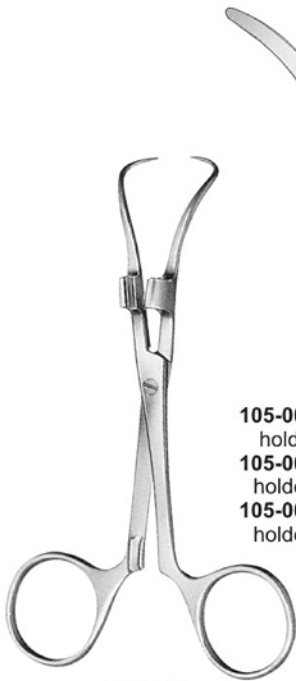

**ROBIN**

- 105-0054** 140mm (5.1/2")  
holder diameter 5mm
- 105-0055** 140mm (5.1/2")  
holder diameter 13mm
- 105-0056** 140mm (5.1/2")  
holder diameter 25mm

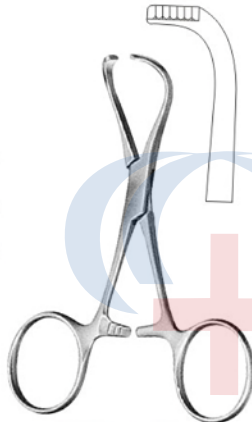

**EDNA (LORNA)**  
**105-0057**  
100mm (4")

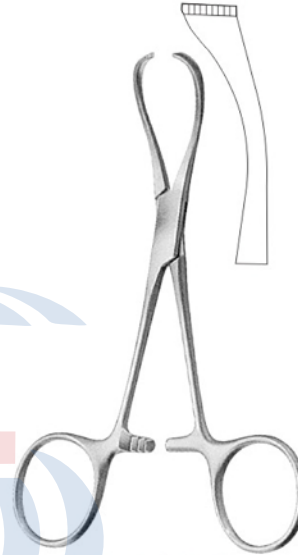

**EDNA (LORNA)**  
**105-0058**  
130mm (5.1/4")

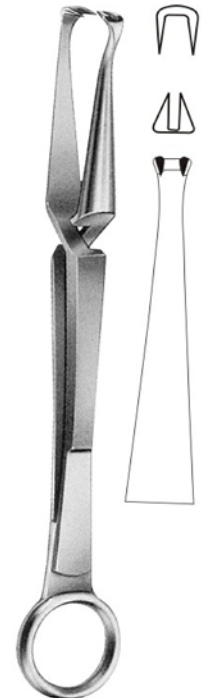

**DOYEN**  
**105-0059**  
190mm (7.1/2")

# S.S. Surgimed

World Class Instruments Since 1980



**BALL AND SOCKET**  
**105-0062** 130mm (5")

**105-0060**  
90mm (3.1/2")

**105-0061**  
100mm (4.3/4")

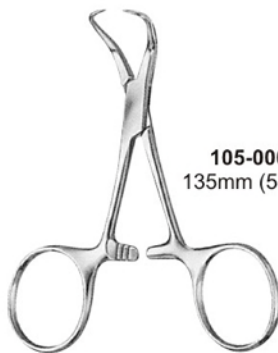

**BACKHAUS**

**105-0063**  
135mm (5.1/4")

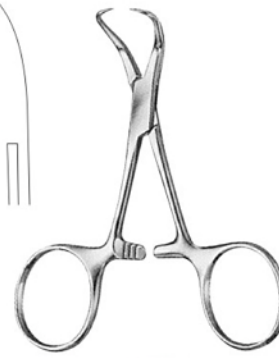

**MAYO**  
**105-0064** 140mm (5.1/2")

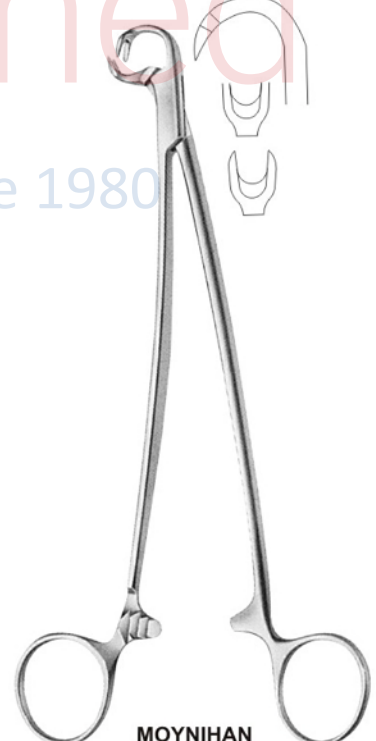

**MOYNIHAN**  
**105-0065**  
190mm (7.1/2") 2 x 2 teeth

## ●●● Sponge Holding Forceps



**RAMPLEY**

**105-0066**  
180mm (7")

**105-0067**  
240mm (9.1/2")

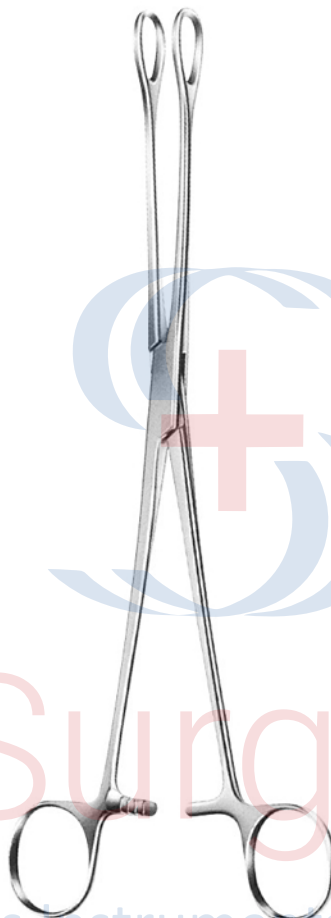

**FORESTER**

**105-0068**  
240mm (9.1/2")

**105-0069**  
180mm (7")  
Straight

**105-0070**  
240mm (9.1/2")

**105-0071**  
180mm (7")  
Curved on flat

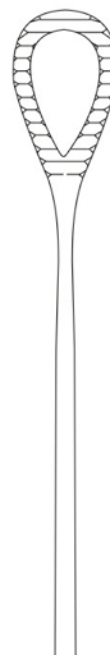

**105-0072**



**105-0073**

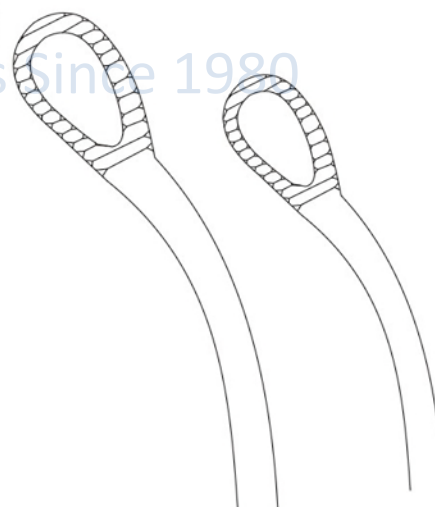

**105-0074**

**105-0075**



S.S. Surgimed

World Class Instruments Since 1980

# SURGICAL INSTRUMENTS

## Dressing Forceps ●●●



**BOZEMANN UTERINE DRESSING FORCEPS**  
**105-0076** 255mm (10")  
Jaws with longitudinal groove

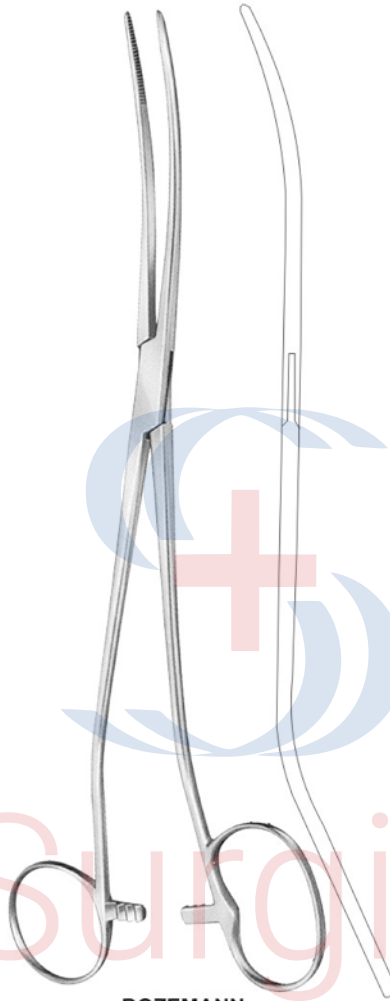

**BOZEMANN**  
**105-0077** 260mm (10.1/4")  
Serrated jaws, on large bow



**BOZEMANN**  
**105-0078** 250mm (10")  
S-shaped curve

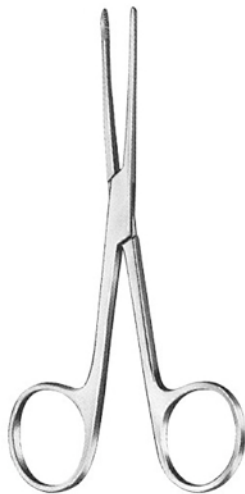

**LISTER - SINUS**



**105-0079**  
125mm (5")



**105-0080**  
150mm (6")



**105-0081**  
180mm (7")

## ●●● Haemostats Forceps



**HALSTEAD MOSQUITO**  
**106-0001** 100mm (4")  
 Straight



**HALSTEAD MOSQUITO**  
**106-0002** 100mm (4")  
 Curved on flat



**HALSTEAD MOSQUITO**  
 100mm (4")  
 1 x 2 teeth  
**106-0003**  
 Straight  
**106-0004**  
 Curved on flat



**HALSTEAD MOSQUITO**  
 125mm (5")  
**106-0005**  
 Straight  
**106-0006**  
 Curved on flat



**HALSTEAD MOSQUITO**  
 125mm (5")  
 1 x 2 teeth  
**106-0007**  
 Straight  
**106-0008**  
 Curved on flat



**BABY - CRILE**  
**106-0009**  
 140mm (5.1/2")  
 Straight





S.S. Surgimed

World Class Instruments Since 1980

# SURGICAL INSTRUMENTS

## Haemostats Forceps ●●●



**BABY-CRILE**  
106-0010 140mm (5.1/2")  
Curved on flat

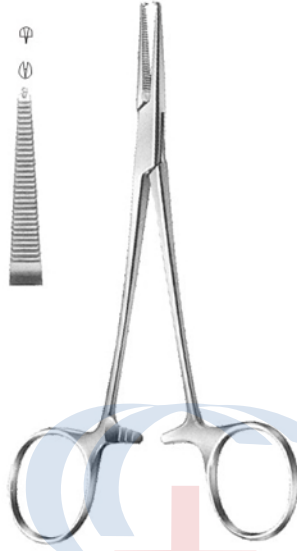

**BABY-CRILE**  
106-0011 140mm (5.1/2")  
Straight  
1 x 2 teeth



**BABY CRILE**  
106-0012 140mm (5.1/2")  
Curved on flat  
1 x 2 teeth

# S.S. Surgimed

World Class Instruments Since 1980

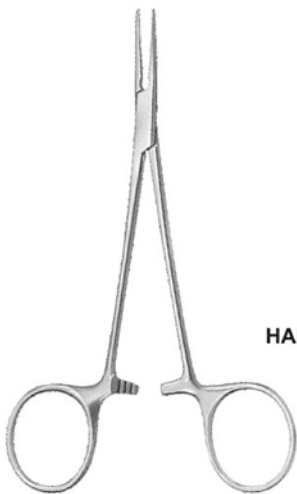

**HALSTEAD MOSQUITO**  
125mm (5")  
106-0013  
Straight  
106-0014  
Curved on flat



**HALSTEAD MOSQUITO**  
125mm (5")  
1 x 2 teeth  
106-0015  
Straight  
106-0016  
Curved on flat

## ●●● Haemostats Forceps



**106-0017**  
145mm (5.3/4")  
**106-0018**  
180mm (7")

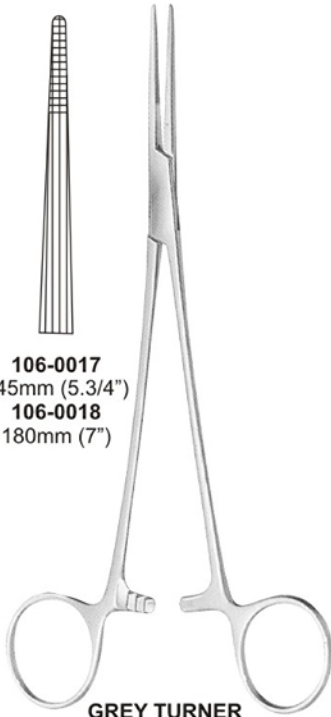

**GREY TURNER**  
Straight



**106-0019**  
145mm (5.3/4")  
**106-0020**  
180mm (7")

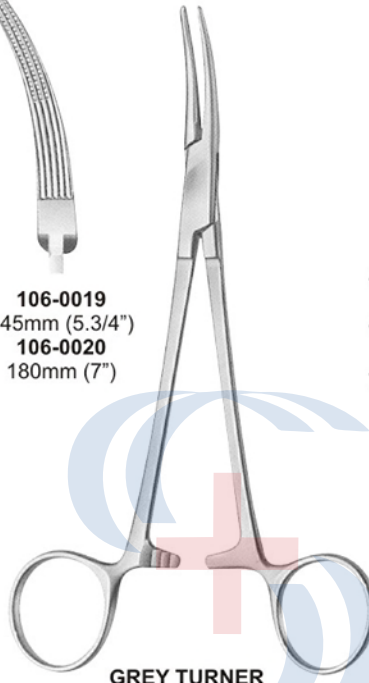

**GREY TURNER**  
Curved on flat



**106-0021** 145mm (5.3/4")  
Straight  
**106-0022** 145mm (5.3/4")  
Curved on flat  
**106-0023** 145mm (5.3/4")  
Curved to side



**CUSHING**



**106-0024**  
254mm (9.3/4")  
Curved on flat



**CRAFOORD**



**106-0025**  
140mm (5.1/2")  
**106-0026**  
160mm (6.1/4")  
**106-0027**  
180mm (7")

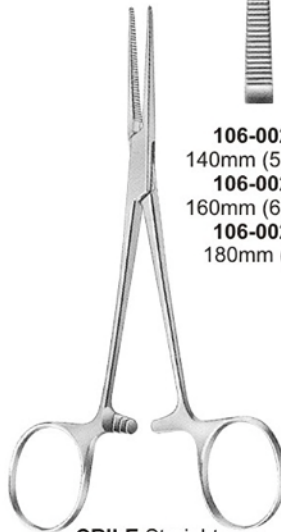

**CRILE** Straight



**106-0028**  
145mm (5.3/4")  
**106-0029**  
145mm (5.3/4")  
Curved on flat  
**106-0030**  
145mm (5.3/4")  
Curved to side

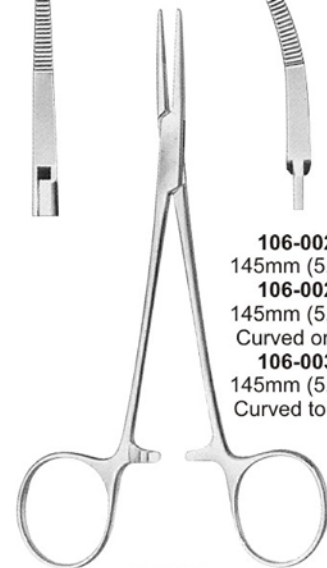

**CAIRNS**



S.S. Surgimed

World Class Instruments Since 1980

# SURGICAL INSTRUMENTS

## Haemostats Forceps ●●●



**CRILE**  
1 x 2 teeth  
106-0031 160mm (6.1/4")  
Straight  
106-0032 160mm (6.1/4")  
Curved on flat  
106-0033 140mm (5.1/2")  
Straight  
106-0034 140mm (5.1/2")  
Curved on flat

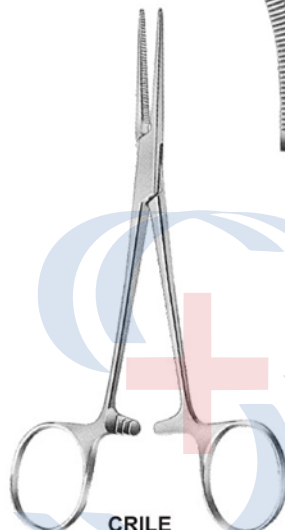

**CRILE**  
Curved on flat  
106-0035 140mm (5.1/2")  
106-0036 160mm (6.1/4")



**KELLY-CRILE**  
Straight  
106-0037 140mm (5.1/2")  
106-0038 160mm (6.1/4")

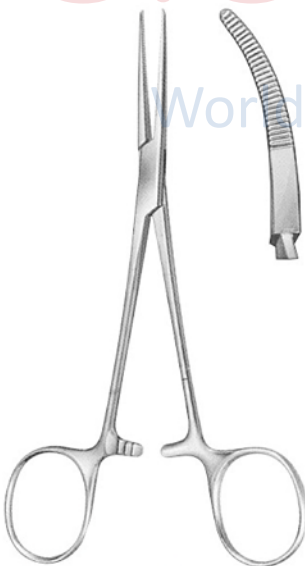

**KELLY**  
Curved on flat  
106-0039 140mm (5.1/2")  
106-0040 160mm (6.1/4")

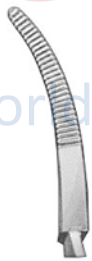

**KELLY HALSTEAD**  
Straight  
106-0041 140mm (5.1/2")  
Curved on flat  
106-0042 140mm (5.1/2")

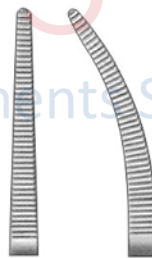

**KOCHER**  
Straight 1 x 2 teeth  
106-0043 125mm (5")  
106-0044 140mm (5.1/2")  
106-0045 150mm (6")  
106-0046 180mm (7")  
106-0047 200mm (8")  
106-0048 225mm (9")



## ●●● Haemostats Forceps



**KOCHER**  
Curved on flat 1 x 2 teeth  
**106-0049** 125mm (5")  
**106-0050** 140mm (5.1/2")  
**106-0051** 150mm (6")  
**106-0052** 180mm (7")  
**106-0053** 200mm (8")  
**106-0054** 225 (9")

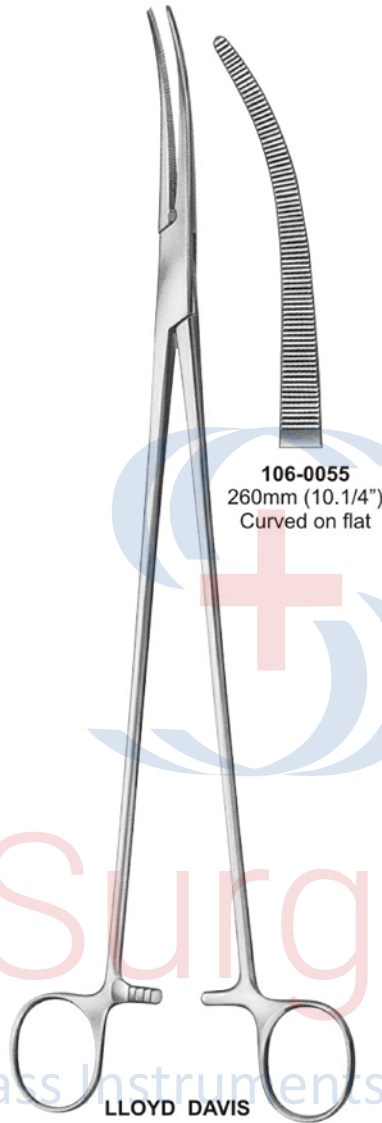

**106-0055**  
260mm (10.1/4")  
Curved on flat



**MAYO**  
**106-0056**  
160mm (6.1/4")  
Curved on flat



**ROCHESTER - OSCHNER**  
Straight 1 x 2 teeth

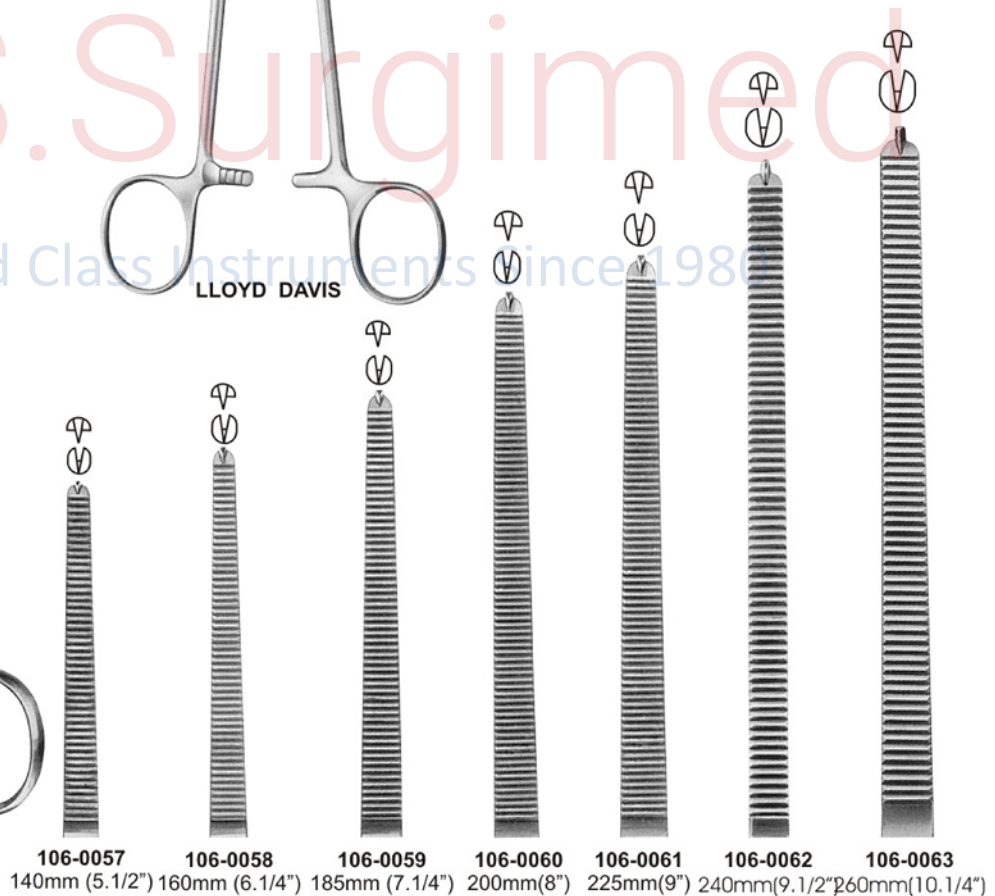

**106-0057** 140mm (5.1/2") **106-0058** 160mm (6.1/4") **106-0059** 185mm (7.1/4") **106-0060** 200mm(8") **106-0061** 225mm(9") **106-0062** 240mm(9.1/2") **106-0063** 260mm(10.1/4")





S.S. Surgimed

World Class Instruments Since 1980

# SURGICAL INSTRUMENTS

## Haemostats Forceps ●●●



**ROCHESTER - OSCHNER**  
Curved  
1 x 2 teeth

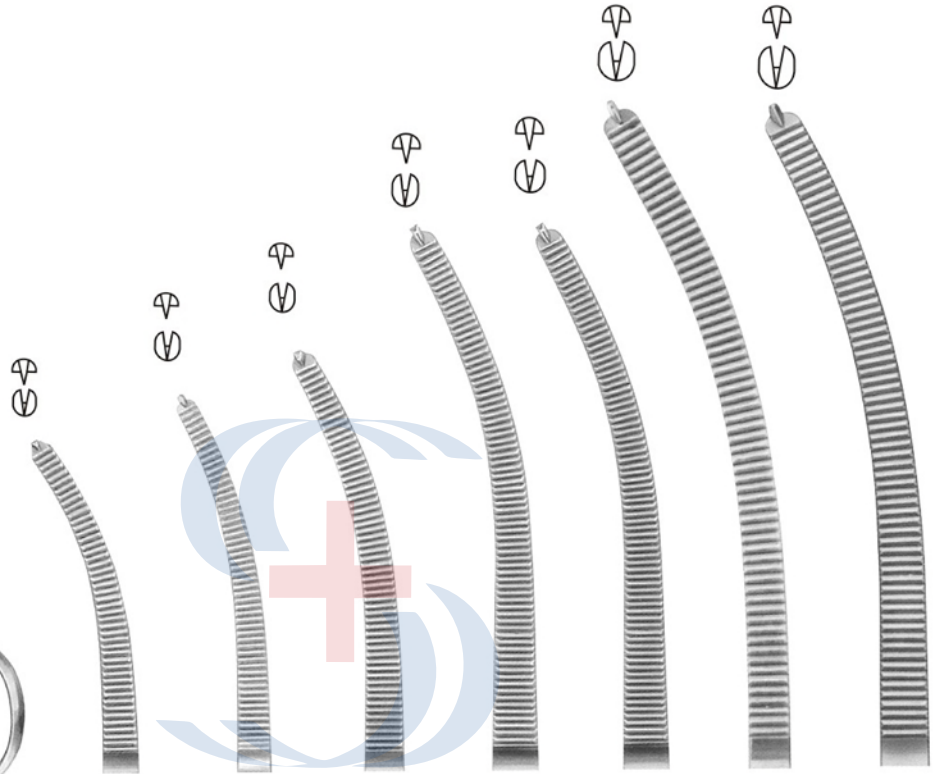

**106-0064**  
140mm  
(5.1/2")

**106-0065**  
160mm  
(6.1/4")

**106-0066**  
185mm  
(7.1/4")

**106-0067**  
200mm  
(8")

**106-0068**  
225mm  
(9")

**106-0069**  
240mm  
(9.1/2")

**106-0070**  
260mm  
(10.1/4")



**FRASER-KELLY (CRILE)**  
106-0071 180mm (7") Curved on flat

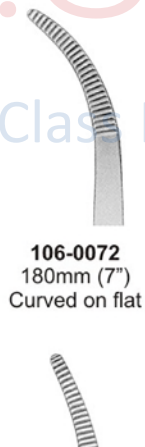

**106-0072**  
180mm (7")  
Curved on flat



**106-0073**  
180mm (7")  
Straight



**106-0074**  
185mm (7.1/4")  
Curved on flat  
1 x 2 teeth



**106-0075**  
185mm (7.1/4")  
Straight  
1 x 2 teeth



**FRASER - ADSON**

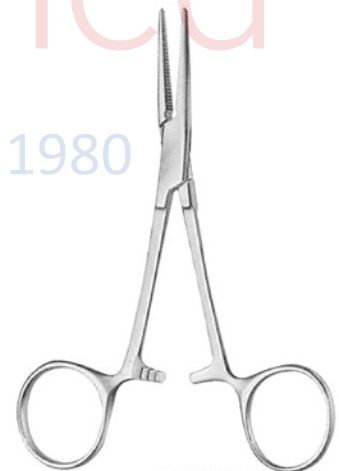

**DUNHILL**  
106-0076 125mm (5")  
Curved on flat  
106-0077 125mm (5")  
Straight  
106-0078 180mm (7")  
Curved on flat



## ●●● Haemostats Forceps



**SPENCER WELLS**  
Straight



**106-0079**  
125mm  
(5")



**106-0080**  
150mm  
(6")



**106-0081**  
180mm  
(7")



**106-0082**  
200mm  
(8")



**106-0083**  
225mm  
(9")



**106-0084**  
125mm  
(5")



**106-0085**  
150mm  
(6")



**106-0086**  
180mm  
(7")



**106-0087**  
200mm  
(8")



**106-0088**  
225mm  
(9")

**SPENCER WELLS**  
Curved on flat



S.S. Surgimed

World Class Instruments Since 1980

# SURGICAL INSTRUMENTS

## Haemostats Forceps ●●●

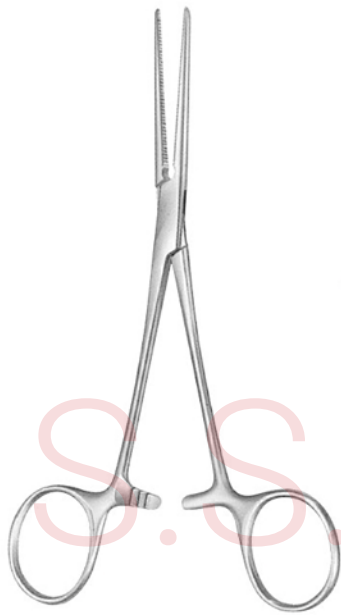

**ROCHSTER PEAN**  
Straight

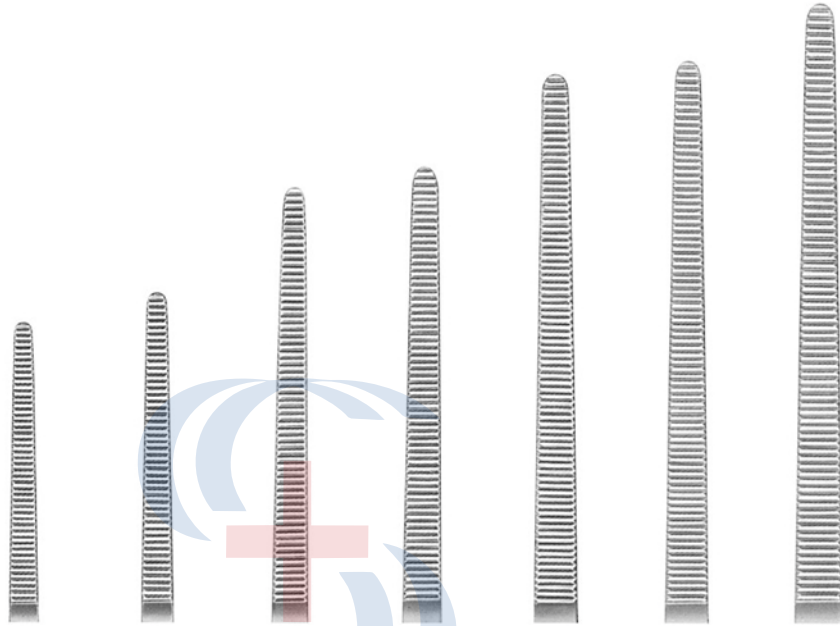

- |                                      |                                      |                                      |                                  |                                  |                                      |                                       |
|--------------------------------------|--------------------------------------|--------------------------------------|----------------------------------|----------------------------------|--------------------------------------|---------------------------------------|
| <b>106-0089</b><br>140mm<br>(5.1/2") | <b>106-0090</b><br>160mm<br>(6.1/4") | <b>106-0091</b><br>185mm<br>(7.1/4") | <b>106-0092</b><br>200mm<br>(8") | <b>106-0093</b><br>225mm<br>(9") | <b>106-0094</b><br>240mm<br>(9.1/2") | <b>106-0095</b><br>260mm<br>(10.1/4") |
|--------------------------------------|--------------------------------------|--------------------------------------|----------------------------------|----------------------------------|--------------------------------------|---------------------------------------|



- |                                      |                                      |                                      |                                  |                                  |                                      |                                       |
|--------------------------------------|--------------------------------------|--------------------------------------|----------------------------------|----------------------------------|--------------------------------------|---------------------------------------|
| <b>106-0096</b><br>140mm<br>(5.1/2") | <b>106-0097</b><br>160mm<br>(6.1/4") | <b>106-0098</b><br>185mm<br>(7.1/4") | <b>106-0099</b><br>200mm<br>(8") | <b>106-0100</b><br>225mm<br>(9") | <b>106-0101</b><br>240mm<br>(9.1/2") | <b>106-0102</b><br>260mm<br>(10.1/4") |
|--------------------------------------|--------------------------------------|--------------------------------------|----------------------------------|----------------------------------|--------------------------------------|---------------------------------------|

**ROCHSTER PEAN**  
Curved on flat

## ●●● Haemostats Forceps



**HEISS**  
**106-0103** 200mm (8")  
 Straight  
**106-0104** 200mm (8")  
 Curved on side  
**106-0105** 200mm (8")  
 Straight 1 x 2 teeth  
**106-0106** 200mm (8")  
 Curved on flat 1 x 2 teeth



**ROBERTS**  
 Curved on flat  
**106-0107** 230mm (9")  
 Screw joint  
**106-0108** 230mm (9")  
 Box joint

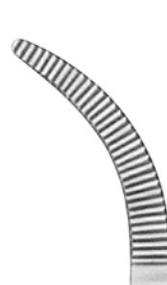

**106-0109**



**106-0110**

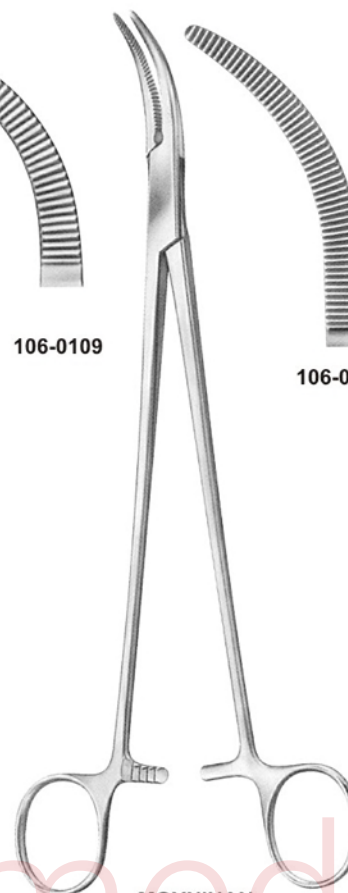

**MOYNIHAN**  
**106-0109** 230mm (9")  
**106-0110** 240mm (9.1/2")



**MIXTER**  
 Curved on flat



**106-0111**  
 140mm (5.1/2")



**106-0112**  
 230mm (9")



**106-0113**  
 180mm (7")



**BIRKETT**

**106-0114** 180mm (7")  
 Straight  
**106-0115** 180mm (7")  
 Curved to side  
**106-0116** 180mm (7")  
 Curved on flat

World Class Instruments Since 1980



S.S. Surgimed

World Class Instruments Since 1980

# SURGICAL INSTRUMENTS

## Haemostats Forceps ●●●



**106-0117**  
150mm  
(6")

**106-0118**  
180mm  
(7")

**106-0119**  
200mm  
(8")

**106-0120**  
230mm  
(9")

**106-0121**  
255mm  
(10")

**O'SHAUGHNESSY**  
Curved, lightweight



**TUBING CLAMP**  
Heavy pattern.  
wedge jaw

**106-0122**  
150mm (6")

**106-0123**  
180mm (7")

**106-0124**  
200mm (8")



**106-0125**

**106-0126**

**FICKLING ORAL**

**106-0127**  
180mm (7")  
Angled to side  
1 x 2 teeth

**106-0128**  
180mm (7")  
Angled to side

## ●●● Tonsil Artery Forceps

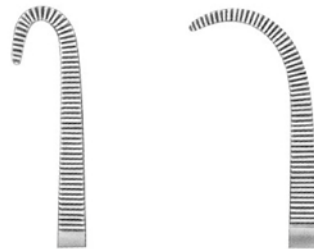

106-0129

106-0130



### SCHNIDT TONSIL

**106-0131**  
180mm (7")  
Slight curved on flat

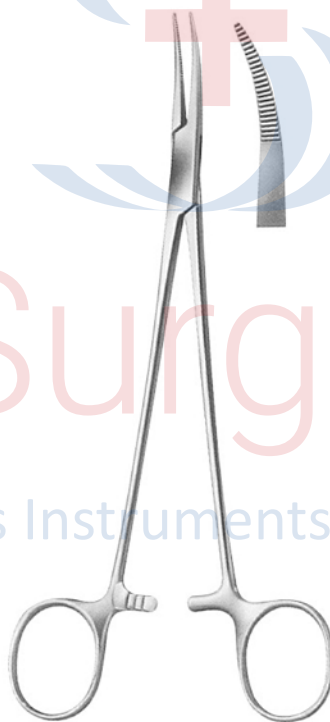

### NEGUS TONSIL

**106-0132**  
180mm (7")  
Small curved

**106-0133**  
180mm (7")  
Large curved



### WILSON TONSIL

**106-0134**  
190mm (7.1/2")  
Curved on flat  
Angled shafts





S.S. Surgimed

World Class Instruments Since 1980

# SURGICAL INSTRUMENTS

## Micro, Needle Holders ●●●



**CASTROVIEJO**  
107-0001  
145mm (5.3/4")  
With catch



**CASTROVIEJO**  
107-0002  
145mm (5.3/4")  
With catch



**ARRUGA**  
107-0003  
135mm (5.1/4")



**BARRAQUER**  
107-0004  
120mm (4.3/4")  
With catch



**BARRAQUER**  
107-0005  
120mm (4.3/4")  
Without catch

# S.S. Surgimed

World Class Instruments Since 1980



**CONVERSE**  
107-0006  
125mm (5")



**DERF**  
107-0007  
120mm (4.3/4")



**MAYO (DUNHILL)**  
107-0008  
160mm (6.1/4")

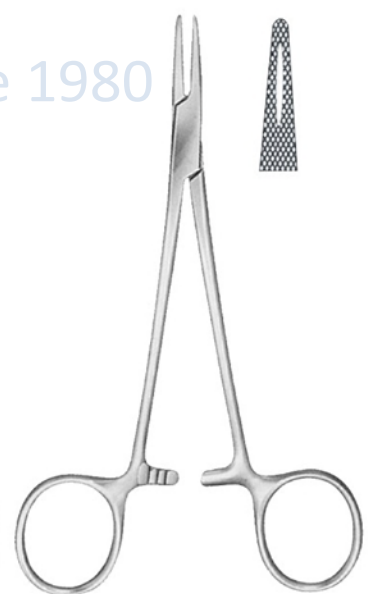

**MAYO**  
107-0009  
180mm (7")



## ●●● Needle Holders



**MAYO**  
107-0010 190mm (7.1/2")



**CRILE WOOD**  
107-0011 150mm (6")



**CRILE MURRAY**  
107-0012 145mm (5.3/4")

S.S. Surgimed

World Class Instruments Since 1980



**KILNER**  
107-0013 135mm (5.1/4")



**NAUNTUN MORGAN**

107-0014  
190mm (7.1/2")  
107-0015  
250mm (10")



**WANGENSTEEN**

107-0016  
270mm (10.3/4")



S.S. Surgimed

World Class Instruments Since 1980

# SURGICAL INSTRUMENTS

## Needle Holders ●●●

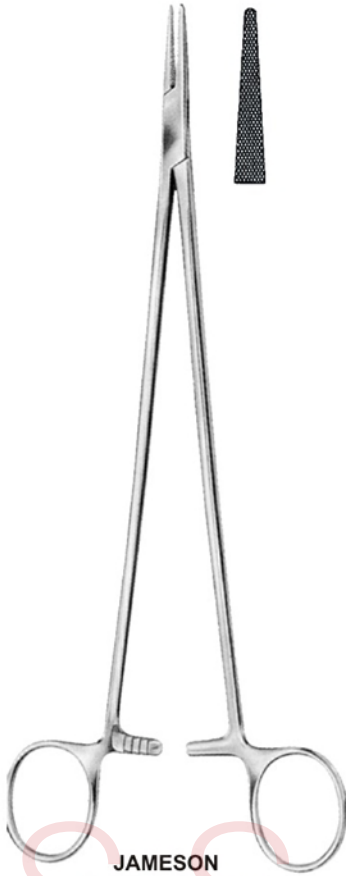

**JAMESON**  
107-0016 230mm (9")



**WRIGHT**  
107-0017 125mm (5")



**GILLIES**  
Combined needle holder  
and scissors  
107-0018 160mm (6.1/4")



**WARD**  
Combined needle holder  
and scissors  
107-0019 180mm (7")



**HEANEY**  
107-0020 200mm (8")

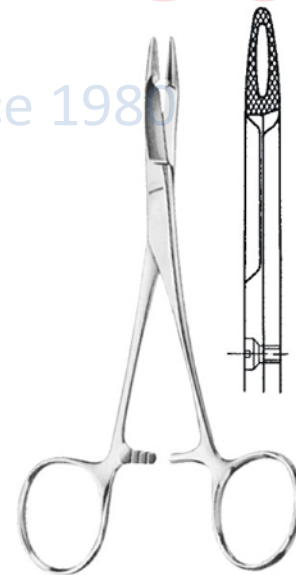

**OLSEN HEGAR**  
Combined needle holder  
and scissors  
107-0021 140mm (5.1/2")  
107-0022 165mm (6.1/2")  
107-0023 190mm (7.1/2")



●●● Needle Holders



**MAYO**



**MAYO (BAUMGARTNER)**  
107-0024 140mm (5.1/2")



**MAYO (MASSON)**  
107-0025 265mm (10.1/2")



**MAYO**  
107-0026 165mm (6.1/2")



**107-0027**  
190mm (7.1/2")



**107-0028**  
200mm (8")



**107-0029**  
230mm (9")



**HEGAR**  
107-0030  
200mm (8")



**HALSEY**  
107-0031  
125mm (5")



**MATHIEU**  
107-0032  
140mm (5.1/2")



S.S. Surgimed

World Class Instruments Since 1980

# SURGICAL INSTRUMENTS

## Needle Holders ●●●



**MATHIEU**  
**107-0033**  
170mm (6.3/4")



**MATHIEU**  
**107-0034**  
200mm (8")



**WEBSTER**  
Smooth Jaw  
**107-0035**  
115mm (4.1/2")

# S.S. Surgimed

World Class Instruments Since 1980



**MAYO**  
**107-0036**  
150mm (6")



**MCPHAILS**  
**107-0037**  
180mm (7")



**LAWRENCE**  
**107-0038** 150mm (6")  
Lightweight  
**107-0039** 150mm (6")





●●● Probes

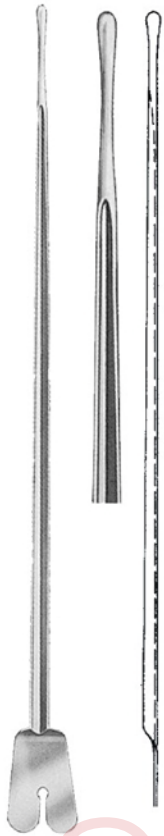

**BRODIE**  
107-0040  
200mm (8")  
Ball point

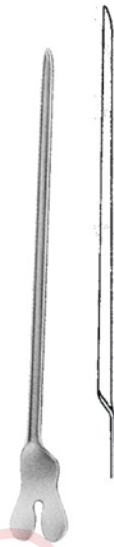

**DIRECTORS**  
107-0041 130mm (5.1/8")  
107-0042 145mm (5.3/4")  
107-0043 160mm (6.1/4")

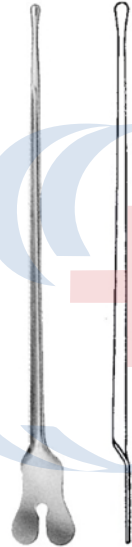

107-0044  
140mm (5.1/2")



**SINUS**  
107-0045  
150mm (6")



**PROBE**  
With Eye

- PROBE**
- 107-0046  
127mm (5")
- 107-0047  
152mm (6")
- 107-0048  
178mm (7")
- 107-0049  
200mm (8")
- 107-0050  
255mm (10")
- 107-0051  
305mm (12")

World Class Instruments Since 1980



**MYRTLE LEAF PROBE**  
107-0052  
145mm (5.3/4")



**1mm Tip**  
107-0053  
145mm (5.3/4")

- | 1.5mm tip                  | 2mm tip                    |
|----------------------------|----------------------------|
| 107-0054<br>130mm (5.1/8") | 107-0060<br>145mm (5.3/4") |
| 107-0055<br>145mm (5.3/4") | 107-0061<br>160mm (6.1/4") |
| 107-0056<br>160mm (6.1/4") | 107-0062<br>180mm (7")     |
| 107-0057<br>180mm (7")     | 107-0063<br>200mm (8")     |
| 107-0058<br>200mm (8")     |                            |
| 107-0059<br>250mm (10")    |                            |



S.S. Surgimed

World Class Instruments Since 1980

# SURGICAL INSTRUMENTS

Probes ●●●



**LIEBRICH LACHRYMAL**

**107-0064**

No. 00 - 0 (0.7 - 0.8mm)

**107-0065**

No. 1 - 2 (0.9 - 1.1mm)

**107-0066**

No. 3 - 4 (1.3 - 1.4mm)

**107-0067**

No. 5 - 6 (1.5 - 1.6mm)



**ANEL LACHRYMAL**

**107-0068**

108mm (4.1/4") 0.6mm , small



**JOBSON HORNE**

**107-0069** 140mm (5.1/2")

**107-0070** 178mm (7")



**FISTULA PROBE**

**107-0071** 240mm (9.1/2")

World Class Instruments Since 1980



**KINGS COLLEGE HOSPITAL**

**COCAINISING WIRE**

**107-0072** 89mm (3.1/2")

**107-0073** 133mm (5.1/4")



**LOGAN TURNER**

**107-0074** 120mm (4.3/4")

1.00mm diameter



**CAWTHORNE**

**107-0075**

140mm (5.1/2")

● ● ● Dissectors

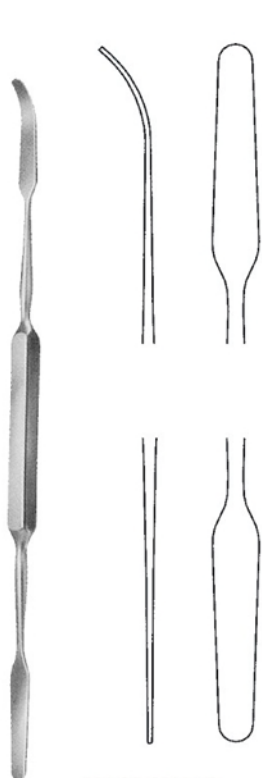

**MACDONALD**  
107-0076 185mm (7.1/4")  
Double ended



**WATSON CHEYNE**  
Fine with probe  
107-0077 125mm (5")  
107-0078 190mm (7.1/2")

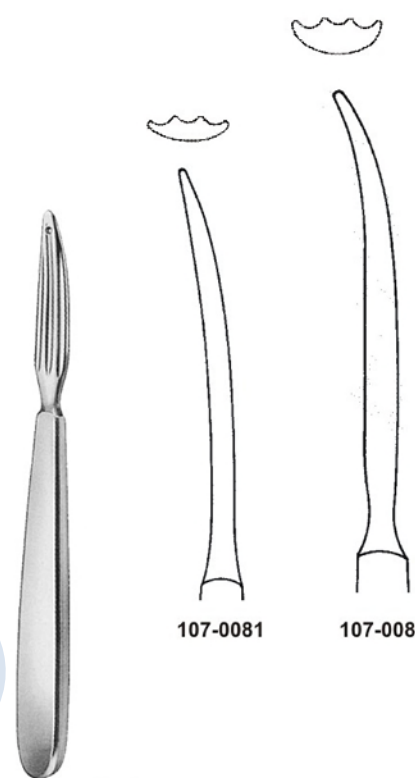

107-0081

107-0082

**KOCHER THYROID**  
107-0079 150mm(6")  
107-0080 170mm (6.3/4")

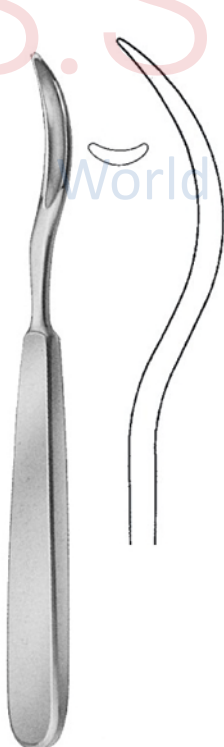

**KOCHER THYROID**  
107-0083 190mm (7.1/2")



**KING**  
107-0084 195mm (7.3/4")

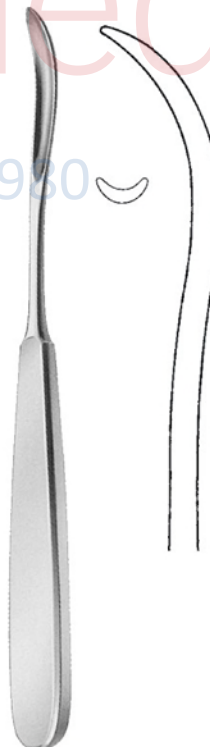

**KING**  
107-0085 200mm (8")



S.S. Surgimed

World Class Instruments Since 1980

# SURGICAL INSTRUMENTS

## Dissectors, Suture Instruments ●●●

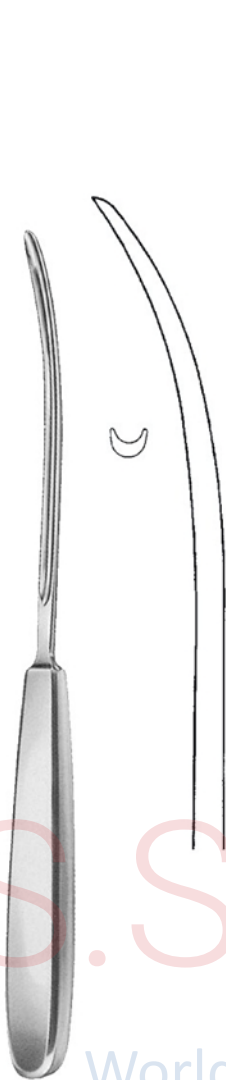

**PAYR**  
107-0086 225mm (9")

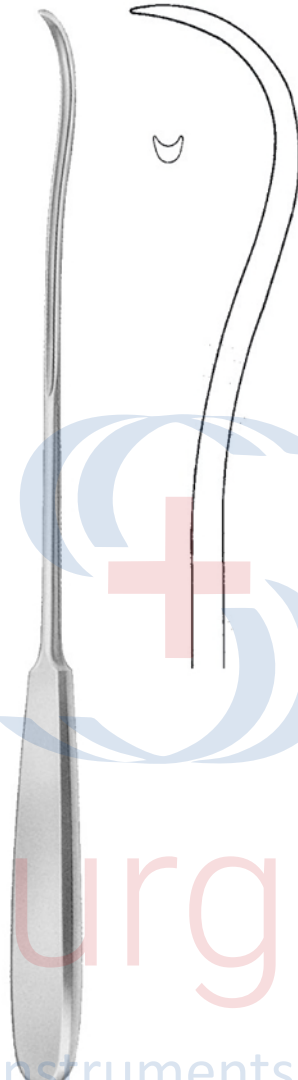

**PAYR**  
107-0087 280mm (11")



**GWYNNE EVANS TONSIL**  
200mm (8")  
Double ended  
107-0088 6mm wide  
107-0089 8mm wide

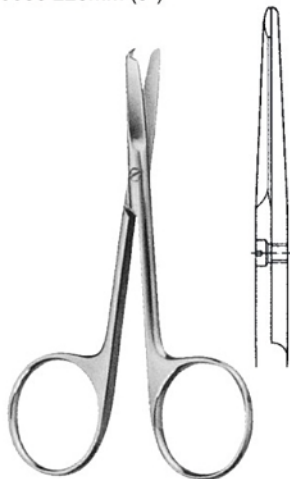

**LITTAUER**  
107-0090 110mm (4.1/2")  
With hook end



**LITTAUER (SPENCER)**  
107-0091 80mm (3.1/2")  
With hook end



**CHARNLEY SUTURE FORCEPS**



107-0092  
180mm (7")  
107-0093  
125mm (5")



## ● ● ● Hand Held Retractors



**DEAVER  
108-0001**  
215mm (8.1/2")  
Blade: 22mm wide

**DEAVER  
108-0002**  
300mm (12")  
Blade: 25mm wide

**DEAVER  
108-0003**  
315mm (12.1/2")  
Blade: 25mm wide

**DEAVER  
108-0004**  
300mm (12")  
Blade: 38mm wide

**DEAVER  
108-0005**  
310mm (12.1/4")  
Blade: 50mm wide





S.S. Surgimed

World Class Instruments Since 1980

# SURGICAL INSTRUMENTS

## Hand Held Retractors ●●●



**DEAVER GRIP**

**No 1**  
**108-0006**  
310mm (12.1/4")  
Blade: 25mm wide

**DEAVER GRIP**

**No 2**  
**108-0007**  
310mm (12.1/4")  
Blade: 38mm wide

**DEAVER GRIP**

**No 3**  
**108-0008**  
302mm (12")  
Blade: 50mm wide

**DEAVER GRIP**

**No 4**  
**108-0009**  
310mm (12.1/4")  
Blade: 75mm wide

## ●●● Hand Held Retractors



**RICHARDSON**  
240mm (9.1/2")



**108-0010**  
Blade: 23mm x 20mm

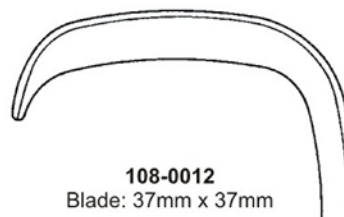

**108-0012**  
Blade: 37mm x 37mm

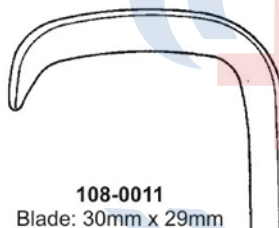

**108-0011**  
Blade: 30mm x 29mm

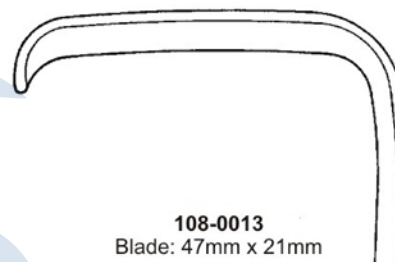

**108-0013**  
Blade: 47mm x 21mm

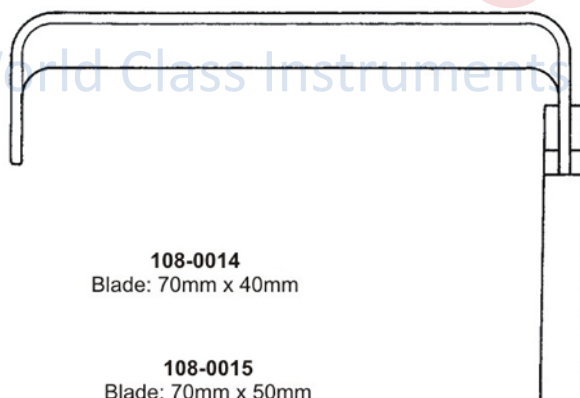

**108-0014**  
Blade: 70mm x 40mm

**108-0015**  
Blade: 70mm x 50mm

**108-0016**  
Blade: 70mm x 65mm



**MORRIS**  
245mm (9.3/4")  
Single blade



S.S. Surgimed

World Class Instruments Since 1980

# SURGICAL INSTRUMENTS

## Hand Held Retractors ●●●

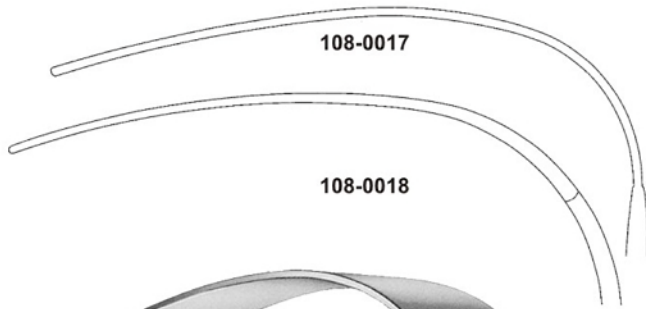

108-0017

108-0018



### KELLY

108-0019

260mm (10.1/4")

Blade: 150mm x 39mm

108-0020

260mm (10.1/4")

Blade: 150mm x 57mm

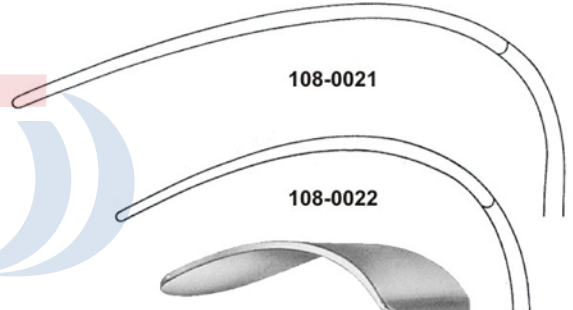

108-0021

108-0022

### LIVER RETRACTORS

250mm (10")

108-0022

Blade: 91mm x 35mm

108-0021

Blade: 121mm x 50mm



S.S. Surgimed

World Class Instruments Since 1980

### ●●● Hand Held Retractors



**MIDDELDORPF**



**108-0023**  
220mm (8.3/4")  
Blade: 15mm x 15mm



**108-0024**  
215mm (8.1/2")  
Blade: 20mm x 22mm



**108-0025**  
235mm (9.1/4")  
Blade: 28mm x 28mm

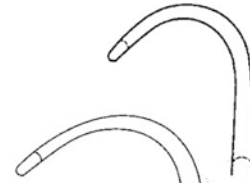

**DURHAM**  
215mm (8.1/2")  
**108-0026** Blade: 10mm  
**108-0027** Blade: 16mm



**KOCHER**  
**108-0028** 230mm (9")  
Blade: 36mm x 20mm



**MOYNIHAN**  
205mm (8")  
**108-0029** Blade: 20mm x 15mm  
**108-0030** Blade: 20mm x 12mm

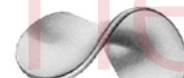

**108-0031**



**108-0032**



S.S. Surgimed

World Class Instruments Since 1980

# SURGICAL INSTRUMENTS

## Hand Held Retractors ●●●



**LANGENBECK**  
215mm (8.1/2")

**108-0033**  
Blade: 25mm x 6mm

**108-0034**  
Blade: 35mm x 8mm

**108-0035**  
Blade: 35mm x 11mm

**108-0036**  
Blade: 35mm x 15mm

**108-0037**  
Blade: 41mm x 11mm

**108-0038**  
Blade: 55mm x 11mm

**108-0039**  
Blade: 70mm x 14mm

**108-0040**  
Blade: 80mm x 16mm



**KOCHER**  
**108-0041** 250mm (10")  
Blade: 67mm x 25mm



**CUSHINGS VEIN**  
**RETRACTORS**  
250mm (10")



**108-0042**  
Blade: 14mm x 11mm



**108-0043**  
Blade: 18mm x 13mm



**108-0044**  
Blade: 22mm x 15mm





## ●●● Hand Held Retractors



**KOCHER**  
230mm (9")

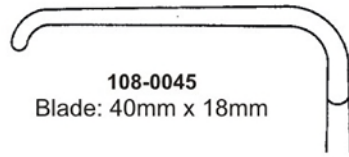

**108-0045**  
Blade: 40mm x 18mm

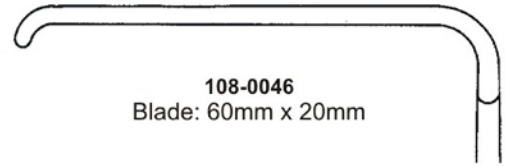

**108-0046**  
Blade: 60mm x 20mm

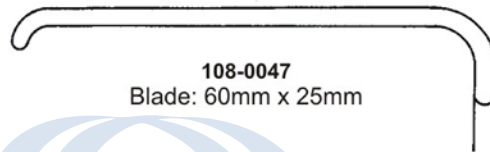

**108-0047**  
Blade: 60mm x 25mm

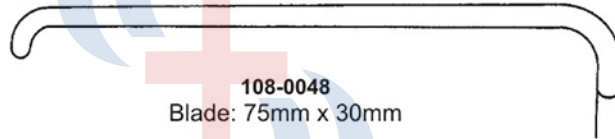

**108-0048**  
Blade: 75mm x 30mm

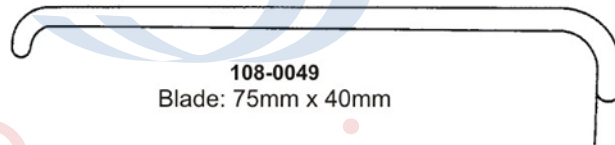

**108-0049**  
Blade: 75mm x 40mm



**FARABEUF 125mm (5")**  
**108-0050**  
Set consisting of  
Inner blade: 22mm x 10mm  
28mm x 12mm  
Outer blade: 25mm x 10mm  
32mm x 12mm

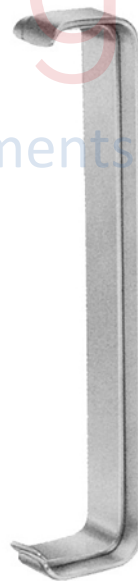

**FARABEUF 150mm (6")**  
**108-0051**  
Set consisting of  
Inner blade: 20mm x 16mm  
24mm x 16mm  
Outer blade: 23mm x 16mm  
28mm x 16mm



**WALTON**  
305mm (12") Malleable  
**108-0052** 13mm wide  
**108-0053** 25mm wide  
**108-0054** 38mm wide  
**108-0055** 51mm wide



S.S.Surgimed

World Class Instruments Since 1980

# SURGICAL INSTRUMENTS

## Hand Held Retractors ●●●



**SIMON**  
108-0056  
220mm (8.3/4")

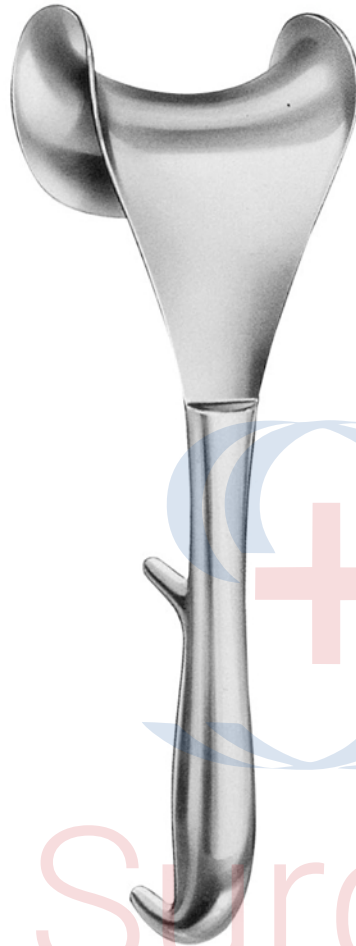

**DOYEN**  
108-0057 250mm (10")  
Blade: 53mm x 80mm

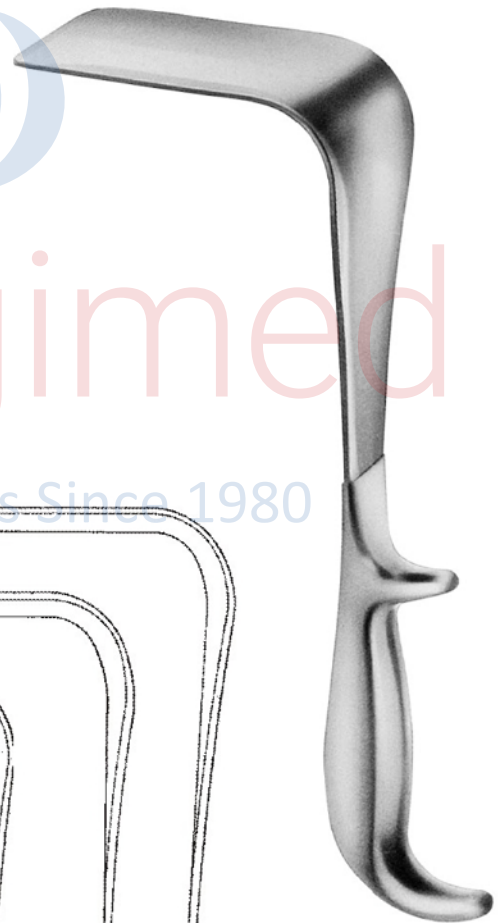

**DOYEN**  
240mm (9.1/2")  
108-0058  
Blade: 60mm x 45mm  
108-0059  
Blade: 90mm x 45mm  
108-0060  
Blade: 120mm x 45mm

World Class Instruments Since 1980

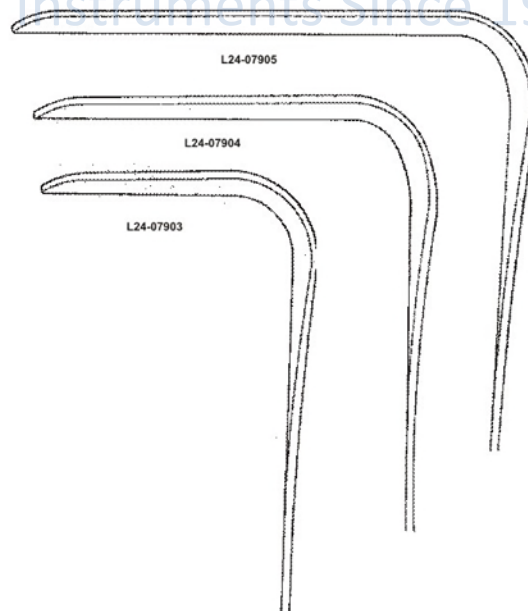



## ●●● Hand Held Retractors

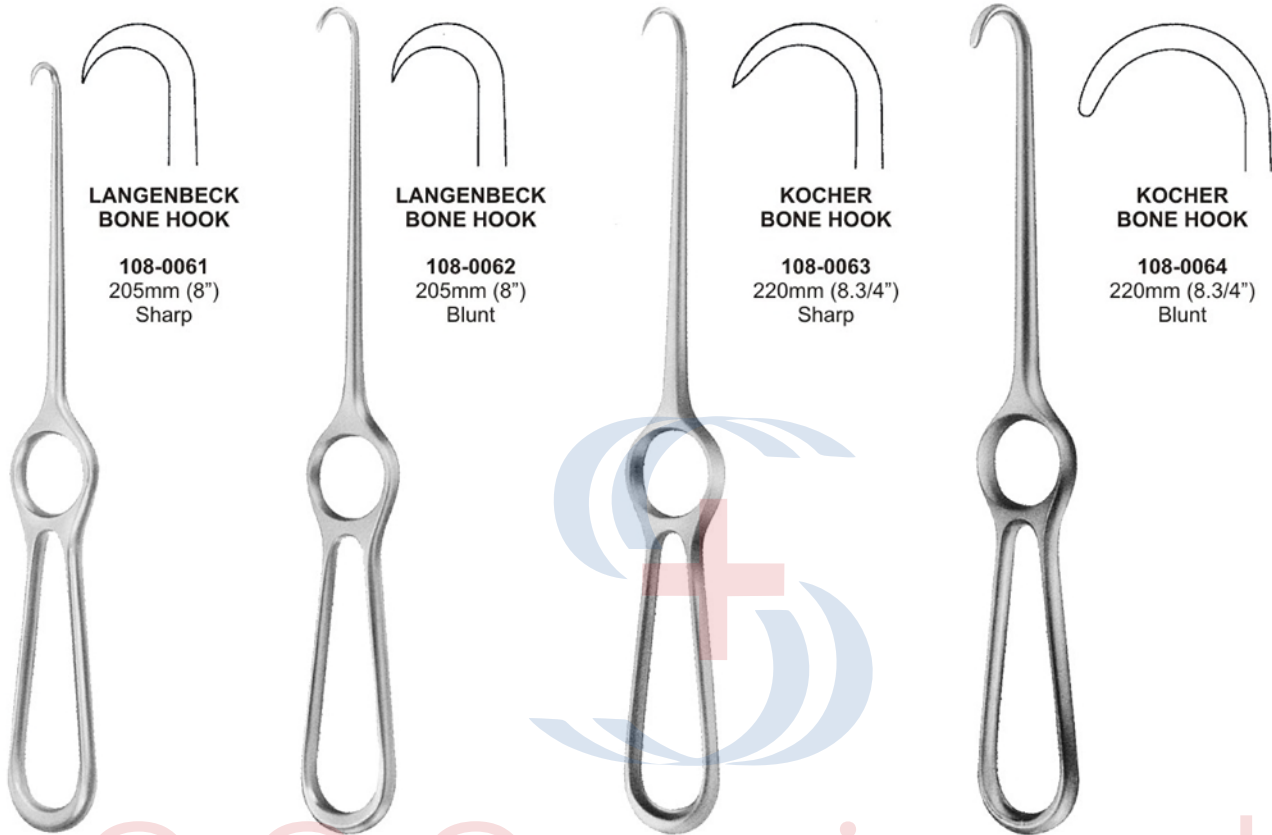

**LANGENBECK  
BONE HOOK**

**108-0061**  
205mm (8")  
Sharp

**LANGENBECK  
BONE HOOK**

**108-0062**  
205mm (8")  
Blunt

**KOCHER  
BONE HOOK**

**108-0063**  
220mm (8.3/4")  
Sharp

**KOCHER  
BONE HOOK**

**108-0064**  
220mm (8.3/4")  
Blunt

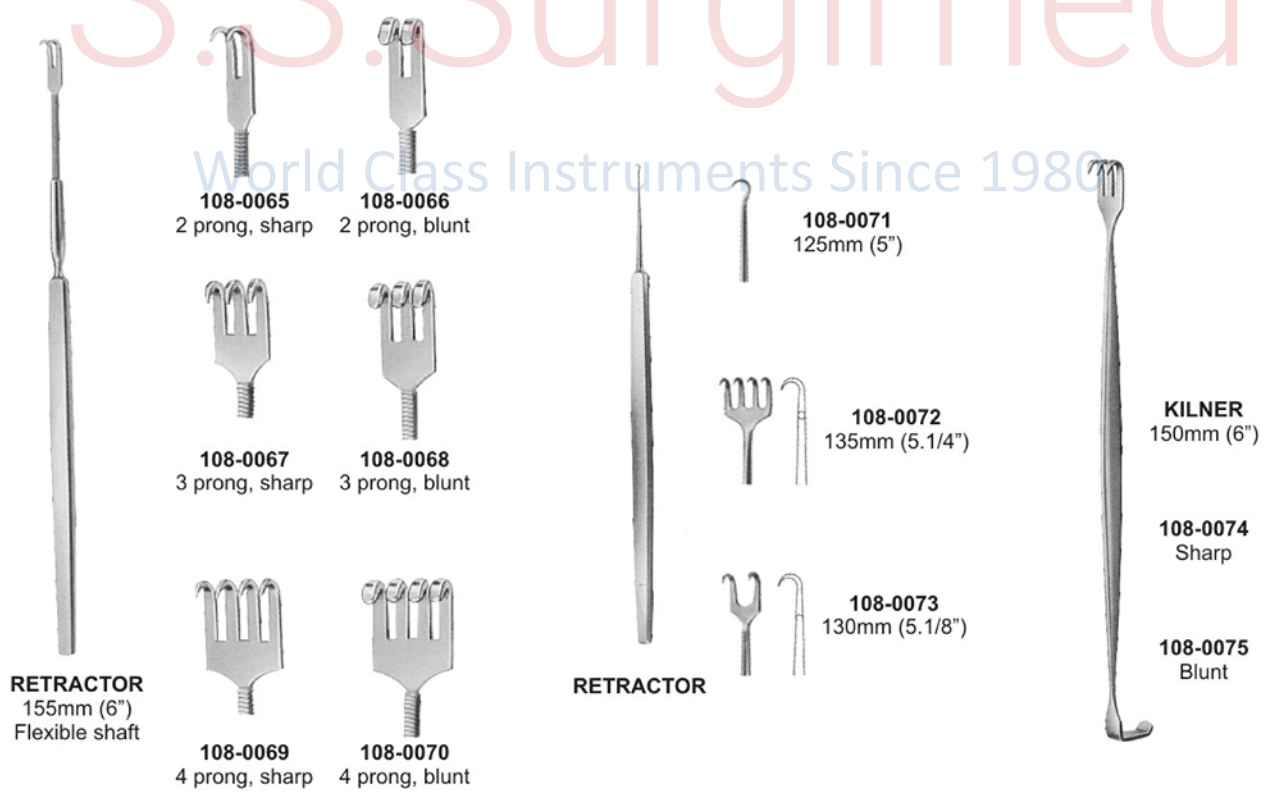

**108-0065**  
2 prong, sharp

**108-0066**  
2 prong, blunt

**108-0071**  
125mm (5")

**108-0067**  
3 prong, sharp

**108-0068**  
3 prong, blunt

**108-0072**  
135mm (5.1/4")

**KILNER**  
150mm (6")

**108-0074**  
Sharp

**RETRACTOR**  
155mm (6")  
Flexible shaft

**108-0069**  
4 prong, sharp

**108-0070**  
4 prong, blunt

**108-0073**  
130mm (5.1/8")

**RETRACTOR**

**108-0075**  
Blunt



**RICARD**  
**108-0076**  
 Lateral blades: 58mm x 80mm  
 Centre blade: 54mm x 70mm  
**108-0077**  
 Lateral blades: 72mm x 84mm  
 Centre blade: 72mm x 90mm

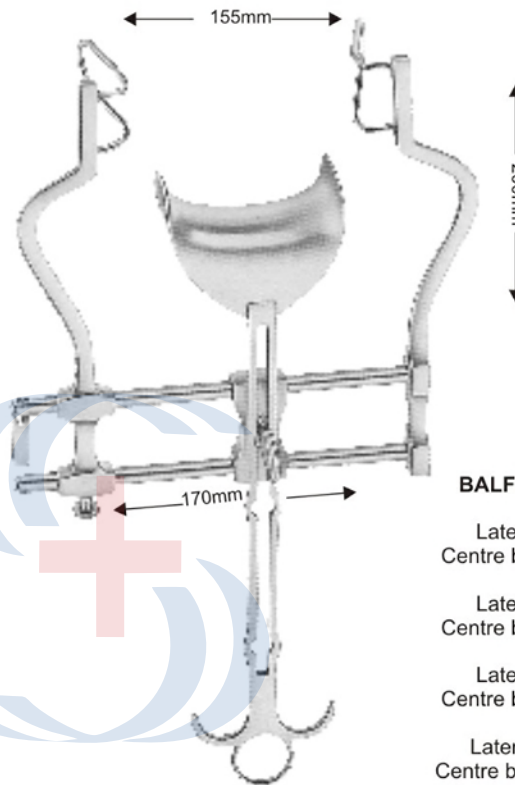

**BALFOUR ABDOMINAL**  
**108-0078**  
 Lateral blades: 60mm  
 Centre blade: 47mm x 80mm  
**108-0079**  
 Lateral blades: 60mm  
 Centre blade: 62mm x 76mm  
**108-0080**  
 Lateral blades: 90mm  
 Centre blade: 80mm x 80mm  
**108-0081**  
 Lateral blades: 105mm  
 Centre blade: 59mm x 107mm

**KIRSCHNER RETRACTOR SET**  
**108-0082**

Set comprising of:  
 1 x 108-0083  
 2 x 108-0084  
 2 x 108-0085

**KIRSCHNER RETRACTOR**  
**FRAME**

**108-0086**  
 255mm square

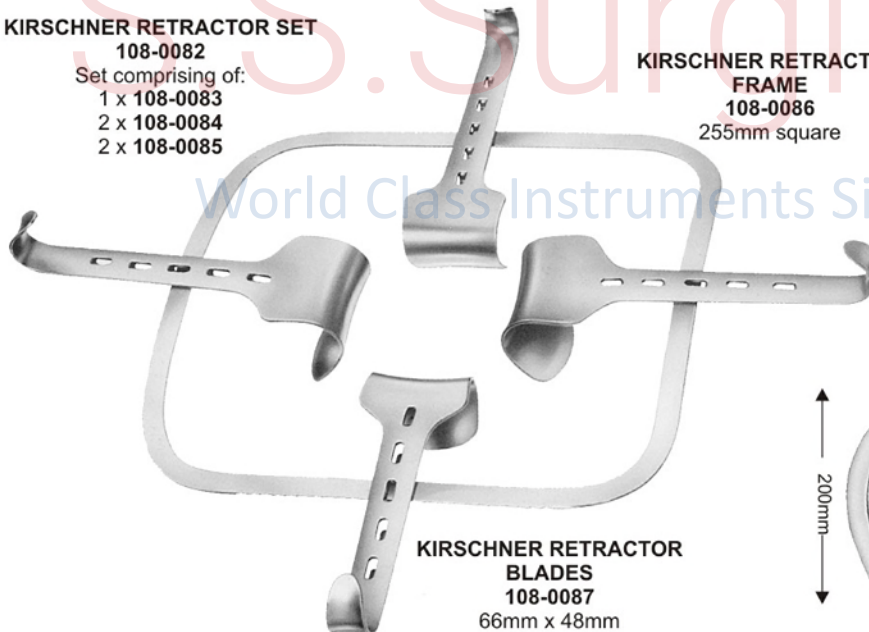

**KIRSCHNER RETRACTOR**  
**BLADES**

**108-0087**  
 66mm x 48mm  
**108-0088**  
 54mm x 42mm  
**108-0089**  
 64mm x 80mm

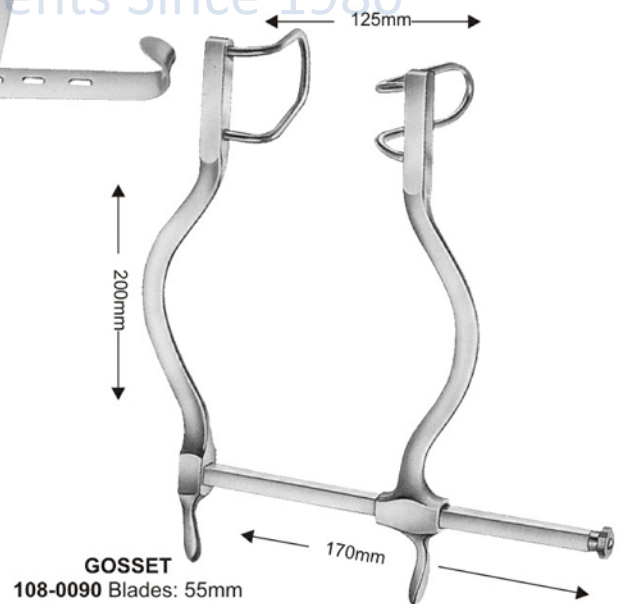

**GOSSET**  
**108-0090** Blades: 55mm

## ●●● Hand Held Retractors

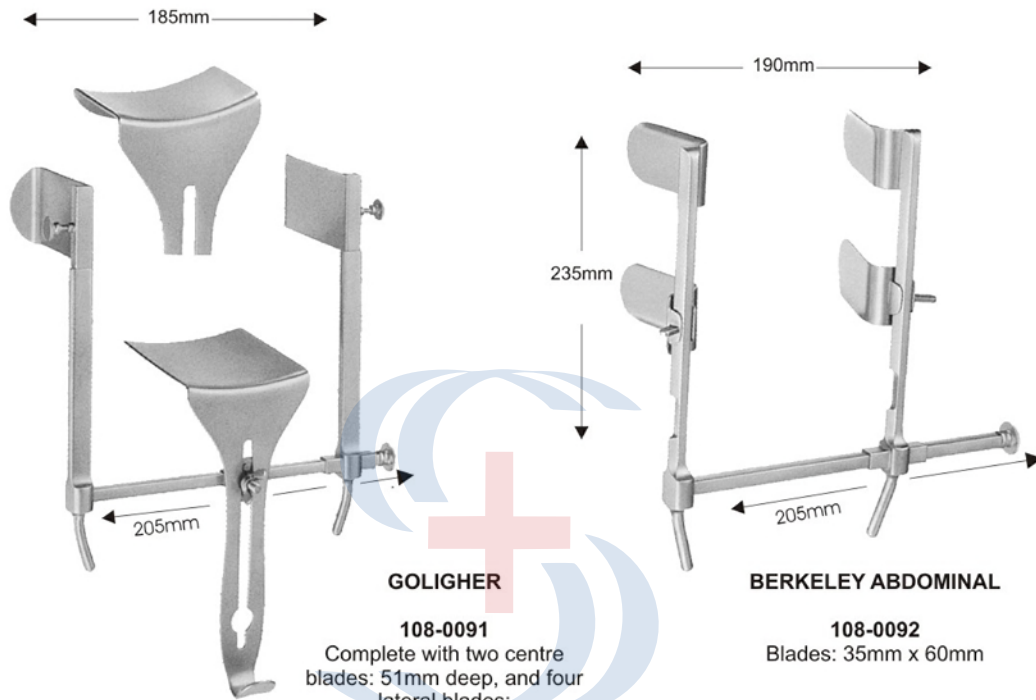

S.S. Surgimed  
World Class Instruments Since 1980







S.S. Surgimed

World Class Instruments Since 1980

# SURGICAL INSTRUMENTS

## Hand Held Retractors ●●●



**WEISLANDER**  
108-0095 110mm (4.3/8")  
2 x 3teeth, sharp



**WEISLANDER**  
108-0096 110mm (4.3/8")  
2 x 3 teeth, blunt



**RNTNE HOSPITAL**  
108-0097 159mm (6.1/4")  
3 x 4 teeth



**NORFOLK AND NORWICH**  
108-0098 215mm (8.1/2")  
4 x 5 teeth, blunt



**WEISLANDER**  
3 x 4 teeth, blunt  
108-0099  
130mm (5.1/8")  
108-0100  
156mm (6.1/2")



**WEISLANDER**  
3 x 4 teeth, sharp  
108-0101  
130mm (5.1/8")  
108-0102  
165mm (6.1/2")



**WEISLANDER**  
3 x 4 teeth, semi sharp  
108-0103  
130mm (5.1/8")  
108-0104  
165mm (6.1/2")

## ●●● Hand Held Retractors



**WEISLANDER**



**108-0105**  
195mm (7.3/4")  
3 x 4 teeth  
sharp



**108-0106**  
240mm (9.1/2")  
3 x 4 teeth  
sharp

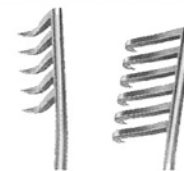

**108-0107**  
255mm (10")  
5 x 6 teeth  
sharp



**108-0108**  
195mm (7.3/4")  
3 x 4 teeth  
blunt

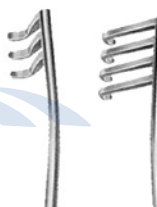

**108-0109**  
240mm (9.1/2")  
3 x 4 teeth  
blunt



**108-0110**  
255mm (10")  
5 x 6 teeth  
blunt



**CONE**

**108-0111**  
145mm (5.3/4")



**JANSON (SHEA)**

**108-0112**  
105mm (4.1/8")

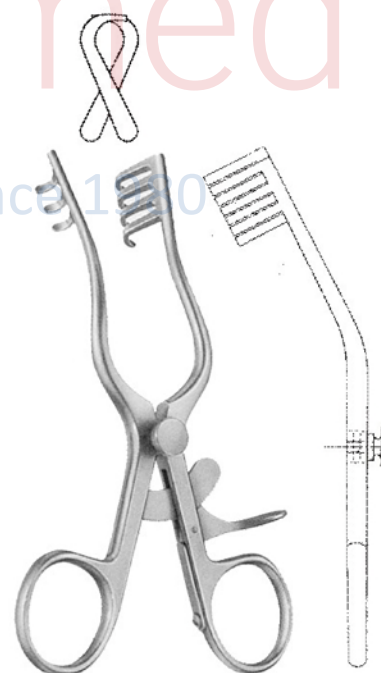

**JEFFERSON**

**108-0113**  
140mm (5.1/2")



S.S. Surgimed

World Class Instruments Since 1980

# SURGICAL INSTRUMENTS

## Cholecystectomy & Gall Stone ●●●

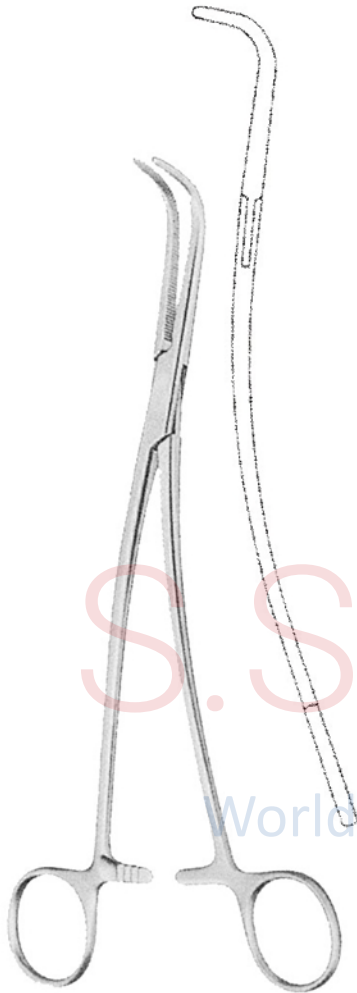

**GEARY GRANT**

**109-0001**  
230mm (9")  
Large curved

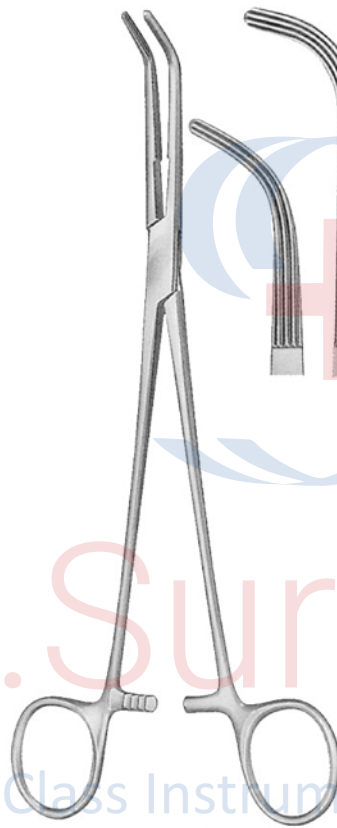

**LAHEY**

**109-0002**  
195mm (7.3/4")

**109-0003**  
230mm (9")



**LOWER**

**109-0004**  
180mm (7")

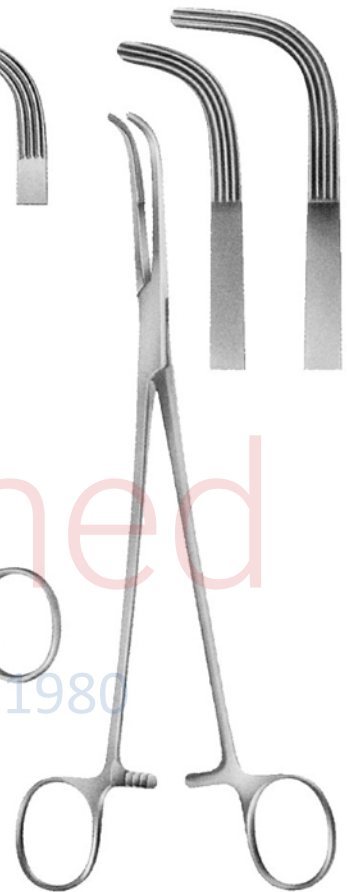

**MIXTER**

**109-0005**  
220mm (8.3/4")

**109-0006**  
250mm (10")

## ●●● Cholecystectomy & Gall Stone

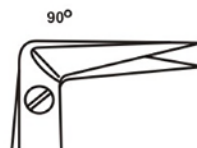

17 cm 6 3/4" "



18 cm / 7" "

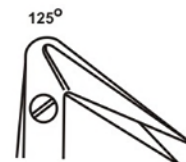

17 cm 6 3/4" "



**MOYNIHAN**

**109-0007**  
230mm (9")

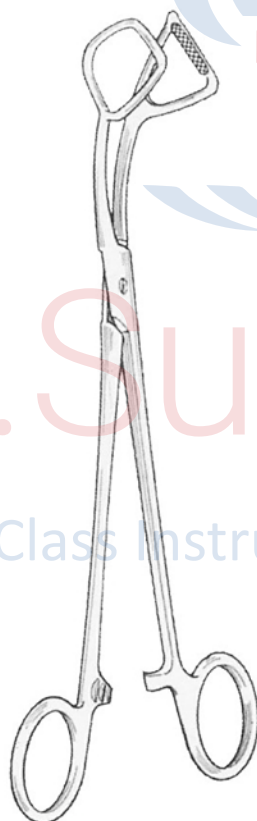

**MOUAT GALL BLADDER  
LIFTING FORCEPS**

**109-0008**  
215mm (8.1/2")



**GALL DUCT SCISSORS**



**POTTS-DE  
MARTEL**

**109-0009**  
220mm (8.3/4")



**MILLS**

**109-0010**  
230mm (8.3/4")



S.S. Surgimed

World Class Instruments Since 1980

# SURGICAL INSTRUMENTS

## Intestinal Clamps ●●●



**DOYEN**  
165mm (6.1/2")  
Spring blades

**109-0011**  
Straight



**109-0012**  
Curved



**109-0015**  
Straight

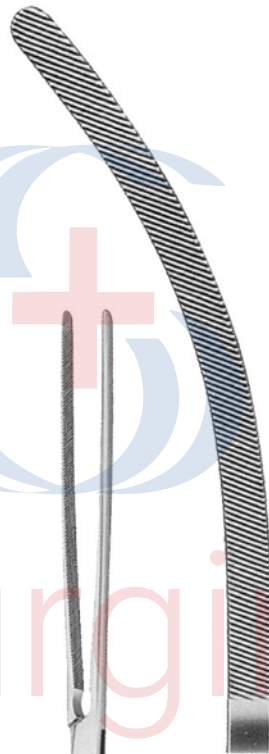

**109-0016**  
Curved



**DOYEN**  
170mm (6.3/4")  
Spring blades

**109-0013**  
Straight



**109-0014**  
Curved

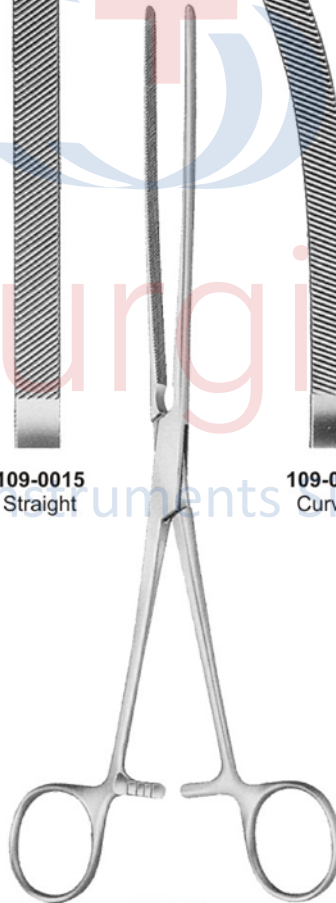

**DOYEN**  
235mm (9.3/4")  
Spring blades



**DOYEN**  
230mm (9")  
Spring blades  
**109-0017** Straight  
**109-0018** Curved



## ● ● ● Intestinal Clamps



**DOYEN (KOCHER)**  
 Straight, light spring blade  
**109-0019**  
 230mm (9")  
**109-0020**  
 250mm (10")  
**109-0021**  
 280mm (11")  
**109-0022**  
 210mm (8.1/4")

**DOYEN (MAYO ROBSON)**  
 Curved, light spring blade  
**109-0023**  
 230mm (9")  
**109-0024**  
 250mm (10")  
**109-0025**  
 280mm (11")  
**109-0026**  
 210mm (8.1/4")

**KOCHER**  
 Spring blades  
**109-0027**  
 250mm (10")  
**109-0028**  
 280mm (11")



S.S. Surgimed

World Class Instruments Since 1980

# SURGICAL INSTRUMENTS

## Intestinal Clamps ●●●



**LANE**  
**109-0029**  
210mm (8.1/4")

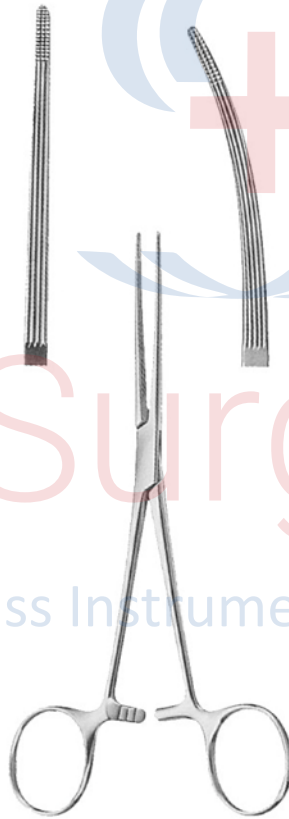

**SETON PRINGLE  
(BAINBRIDGE)**  
**109-0030**  
150mm (6") Straight  
**109-0031**  
150mm (6") Curved

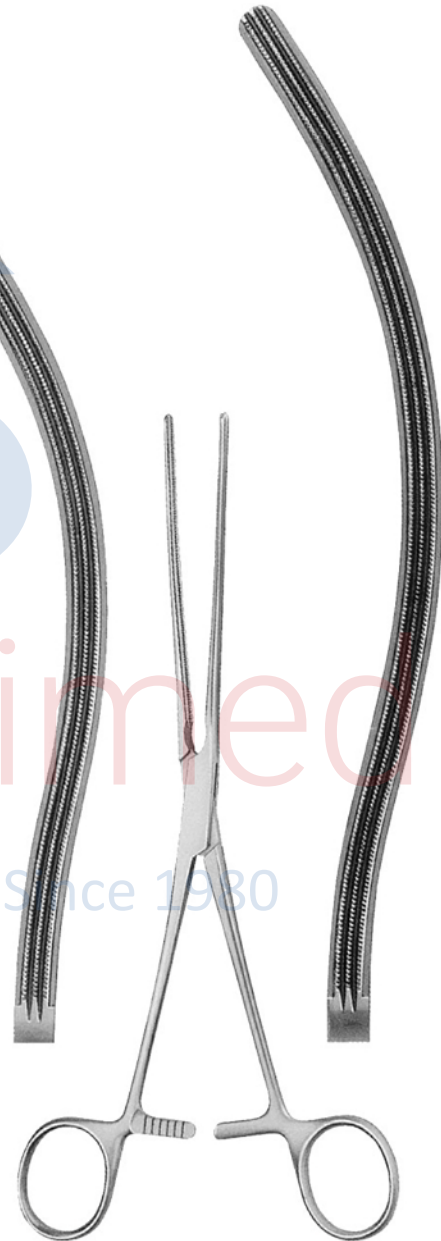

**DOYEN (MAYO ROBSON)**  
Spring blades  
**109-0032**  
250mm (10")  
**109-0033**  
280mm (11")

### ●●● Intestinal Clamps



**SCHOEMAKER**  
Hollow blades for  
hemisphincterectomy  
**109-0034**  
170mm (6.3/4")  
**109-0035**  
215mm (8.1/2")

**PARKER KERR**  
Anastomosis forceps for  
colon resection  
**109-0036**  
250mm (10")

**LANG STEVENSON**  
**109-0037**  
200mm (8")

**PAYR**  
**109-0038**  
200mm (8")  
Jaw: 65mm  
**109-0039**  
280mm (11")  
Jaw: 100mm  
**109-0040**  
350mm (14")  
Jaw: 150mm



S.S. Surgimed

World Class Instruments Since 1980

# SURGICAL INSTRUMENTS

## Intestinal Clamps ●●●



**LANE TWIN ANASTOMOSIS**  
**109-0041**  
300mm (12") Curved

**LANE TWIN ANASTOMOSIS**  
**109-0042**  
300mm (12") Straight

## ●●● Vaginal Speculum



**CUSSO**  
110-0001 75mm x 17mm  
Extra small for virgins



**GRAVE**  
110-0004 75mm x 20mm  
110-0005 95mm x 30mm  
110-0006 195mm x 33mm

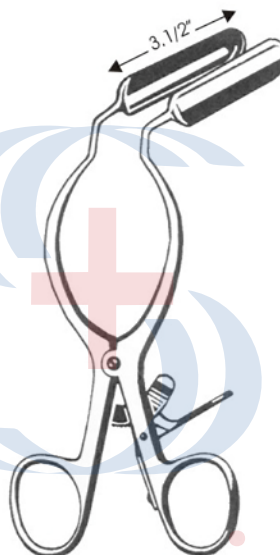

**MCGEE LATERAL  
VIGINAL RETRACTOR**  
with ratch handle  
110-0003

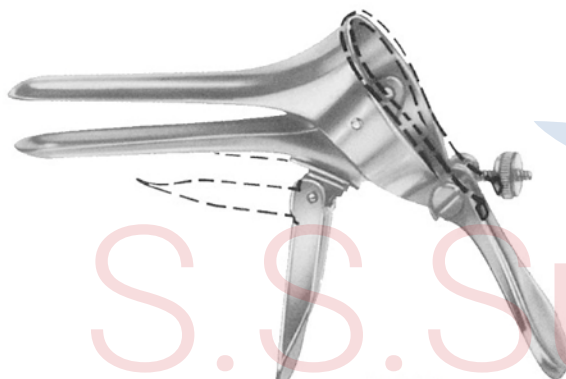

**CUSCO**  
110-0002 75mm x 17mm  
Extra small for virgins



**CUSCO**  
110-0007 110mm x 37mm  
110-0008 80mm x 32mm  
110-0009 80mm x 24mm



**PEDERSON**  
110-0010 100mm x 22 mm  
110-0011 120mm x 25mm





S.S. Surgimed

World Class Instruments Since 1980

# SURGICAL INSTRUMENTS

## Vaginal Speculum ●●●

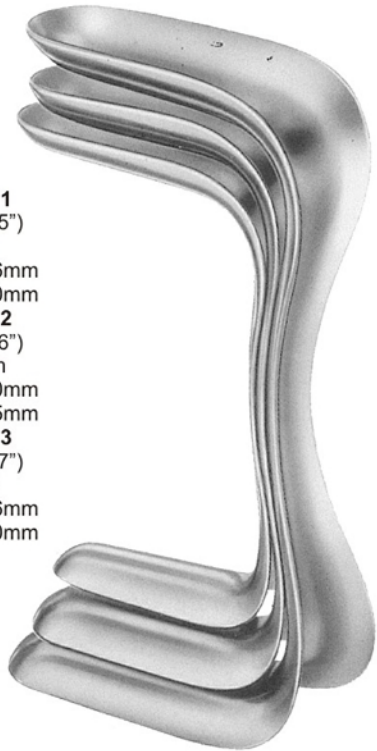

**SIMS**  
**111-0001**  
 125mm (5")  
 Small  
 70mm x 26mm  
 75mm x 30mm  
**111-0002**  
 150mm (6")  
 Medium  
 75mm x 30mm  
 80mm x 35mm  
**111-0003**  
 175mm (7")  
 Large  
 80mm x 36mm  
 90mm x 40mm



Lower blade



Upper blade

**111-0004**  
 175mm (7")  
 Blade:  
 70mm x 15mm

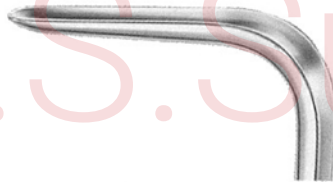

**111-0008**  
 175mm (7")  
 Blade:  
 70mm x 10mm



**111-0005**  
 180mm (7")  
 Blade:  
 70mm x 27mm



**111-0009**  
 180mm (7")  
 Blade:  
 75mm x 23mm



**111-0006**  
 180mm (7")  
 Blade:  
 75mm x 30mm



**111-0010**  
 180mm (7")  
 Blade:  
 80mm x 25mm



**111-0007**  
 185mm (7.1/4")  
 Blade:  
 90mm x 36mm

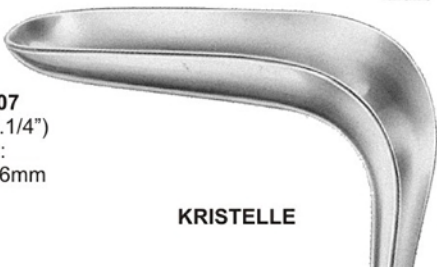

KRISTELLE

**111-0011**  
 185mm (7.1/4")  
 Blade:  
 100mm x 32mm



KRISTELLE

## ●●● Vaginal Speculum



**MATHIEU**  
111-0012  
210mm (8.1/4")  
Blade:  
95mm x 17-30mm  
For children and virgins



**MODIFIED WERTHEIM**  
320mm (12.3/4")

111-0019  
Blade: 100mm x 25mm

111-0020  
Blade: 100mm x 30mm

111-0021  
Blade: 100mm x 35mm

111-0022  
Blade: 100mm x 40mm

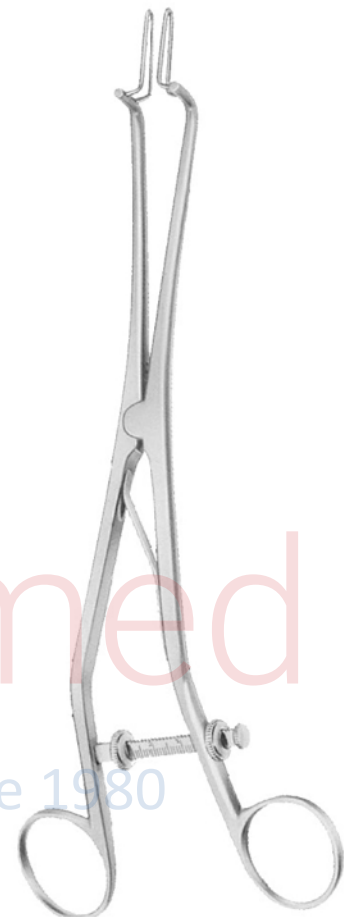

**KOGAN ENDOCERVICAL SPECULUM**

111-0023  
240mm (9.1/2")  
Graduated

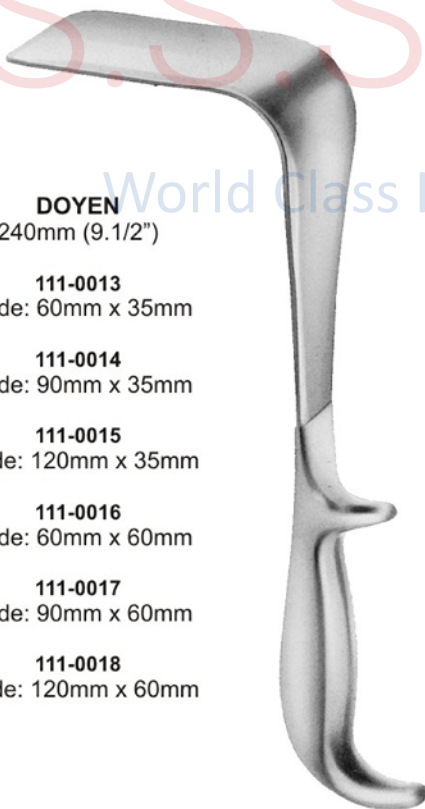

**DOYEN**  
240mm (9.1/2")

111-0013  
Blade: 60mm x 35mm

111-0014  
Blade: 90mm x 35mm

111-0015  
Blade: 120mm x 35mm

111-0016  
Blade: 60mm x 60mm

111-0017  
Blade: 90mm x 60mm

111-0018  
Blade: 120mm x 60mm



S.S. Surgimed

World Class Instruments Since 1980

# SURGICAL INSTRUMENTS

## Vaginal Retractor/ Uterine Dilators ●●●

### AUVARD

**111-0024**  
230mm (9")  
Blade: 63mm x 38-28mm  
Weight: 1.53 Kg (3lb, 60z)  
Fixed weight



### AUVARD

230mm (9")  
Weight: 1.47kg (3lb, 4oz)  
with detachable weight

**111-0025**  
Blade: 75mm x 42-40mm

**111-0026**  
Blade: 105mm x 43-40mm

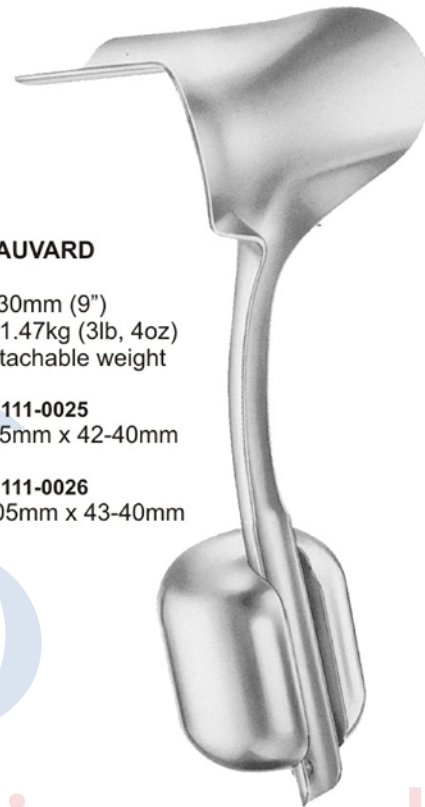

S.S. Surgimed

### O6-09443

Set of twelve

- 111-0027 6mm
- 111-0028 7mm
- 111-0029 8mm
- 111-0030 9mm
- 111-0031 10mm
- 111-0032 11mm
- 111-0033 12mm
- 111-0034 13mm
- 111-0035 14mm
- 111-0036 15mm
- 111-0037 16mm
- 111-0038 17mm



### HAWKIN AMBLER

170mm (6.3/4")  
Cervix dilator

- |               |                |                 |
|---------------|----------------|-----------------|
| 111-0040 2mm  | 111-0052 13mm  | 111-0063 8.5mm  |
| 111-0042 3mm  | 111-0053 14mm  | 111-0064 9.5mm  |
| 111-0043 4mm  | 111-0054 15mm  | 111-0065 10.5mm |
| 111-0044 5mm  | 111-0055 16mm  | 111-0066 11.5mm |
| 111-0045 6mm  | 111-0056 17mm  | 111-0067 12.5mm |
| 111-0046 7mm  | 111-0057 2.5mm | 111-0068 13.5mm |
| 111-0047 8mm  | 111-0058 3.5mm | 111-0069 14.5mm |
| 111-0048 9mm  | 111-0059 4.5mm | 111-0070 15.5mm |
| 111-0049 10mm | 111-0060 5.5mm | 111-0071 16.5mm |
| 111-0050 11mm | 111-0061 6.5mm | 111-0072 17.5mm |
| 111-0051 12mm | 111-0062 7.5mm |                 |

### 111-0039

Set of sixteen  
consisting of one of  
each of: 111-0040 to 111-0056

**HEGAR**  
185mm (7.1/4")  
Cervix dilator





## ●●● Uterine Dilators / Probes



**HEGAR**  
205mm (8")  
Cervix dilator  
Double ended

**111-0073**  
Set of eight consisting  
of one of each of:  
111-0074 to 111-0082

- 111-0074 1mm - 2mm
- 111-0075 3mm - 4mm
- 111-0076 5mm - 6mm
- 111-0077 7mm - 8mm
- 111-0078 9mm - 10mm
- 111-0079 11mm - 12mm
- 111-0080 13mm - 14mm
- 111-0081 15mm - 16mm
- 111-0082 17mm - 18mm

4mm



**GALABIN**

**111-0083**  
290mm (11.1/2")  
Shaft graduated  
is cm's  
Malleable

3mm



**SIMS**

**111-0084**  
330mm (13")

**111-0085**  
330mm (13")  
Malleable



**MARTIN**

**111-0086**  
300mm (12")





S.S. Surgimed

World Class Instruments Since 1980

# SURGICAL INSTRUMENTS

Uterine Dilators Complete Sets ●●●



**111-0087**  
HEGAR  
Dilator set consisting of:  
14 Dilators,  
1 Rack for dilators ( 4- 12 mm)  
1 Rack for Dilators ( 13 - 17 mm)  
1 Metal case only,  
with hinged lid, stainless 200 X 100 X 35 mm

S.S. Surgimed

World Class Instruments Since 1980



**111-0088**  
HEGAR  
Dilator set consisting of:  
26 Dilators,  
1 Rack for dilators ( 1- 17 mm)  
1 Rack for Dilators ( 18 - 26 mm)  
1 Metal case only,  
with hinged lid, aluminium 330 X 220 X 80 mm



## ●●● Tenaculum Forceps

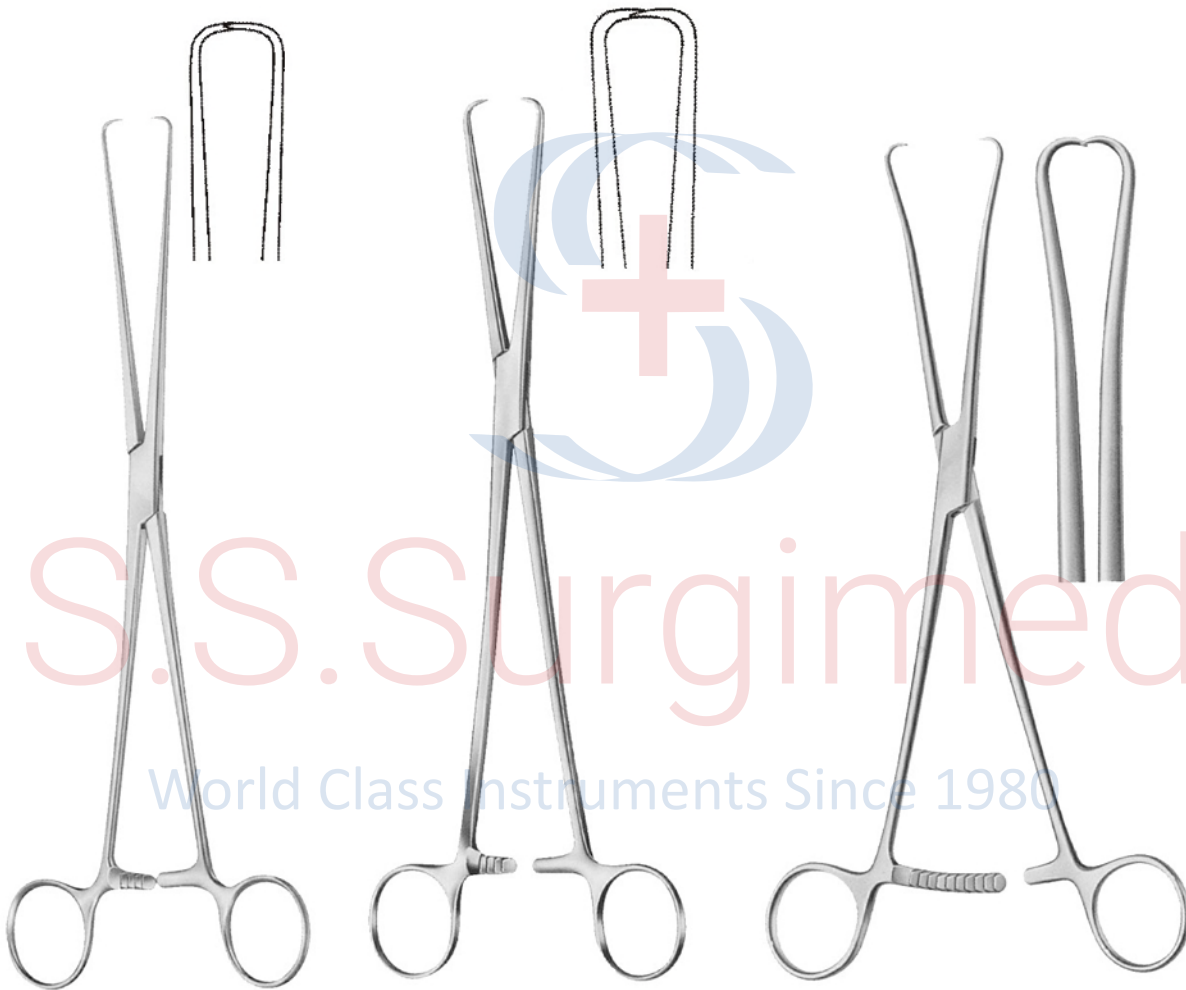

### **BROWN**

**112-0001**  
250mm (10")  
Slender

### **SCHROEDER**

**112-0002**  
230mm (9")

### **WILSON**

**112-0003**  
240mm (9.1/2")



S.S. Surgimed

World Class Instruments Since 1980

# SURGICAL INSTRUMENTS

## Ovum Forceps ●●●



**HEYWOOD SMITH**

**112-0004**  
240mm (9.1/2")

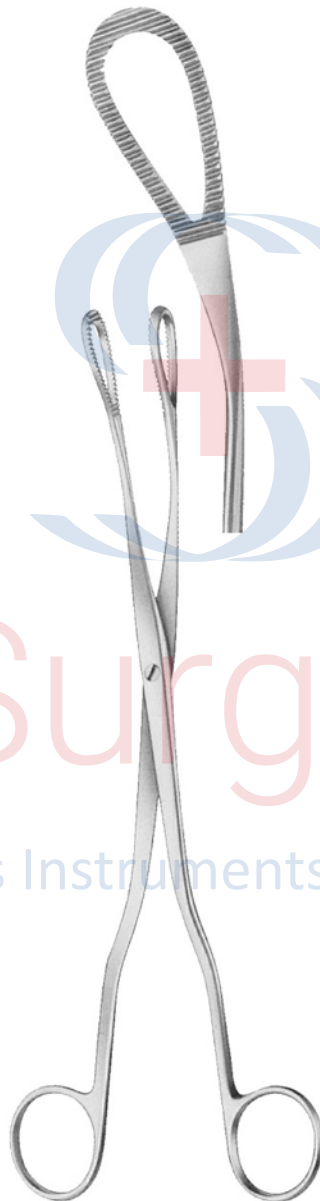

**MCLINTOCK**

**112-0005**  
240mm (9.1/2")

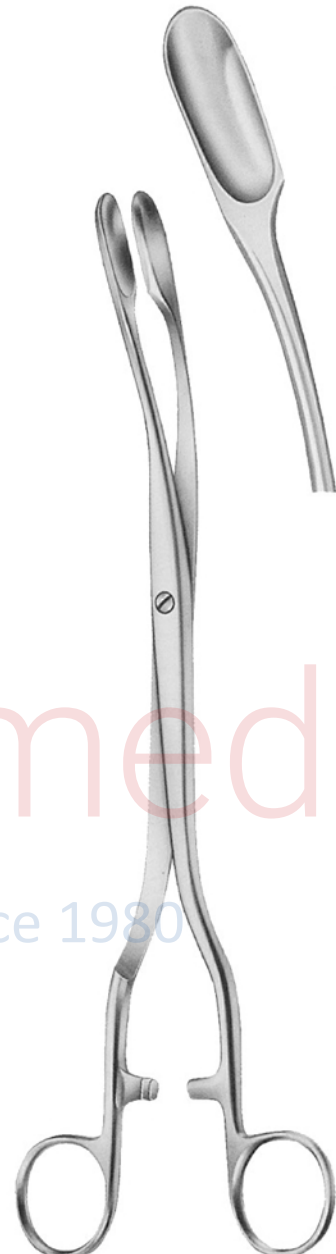

**NOTO**

**112-0006**  
280mm (11")

## ●●● Ovum Forceps



**DOYEN**  
**112-0007**  
185mm (7.1/4")

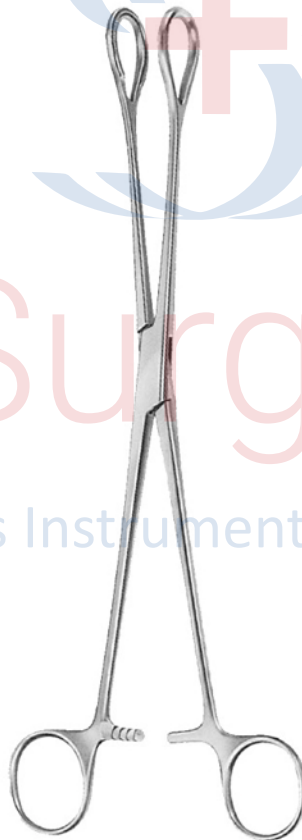

**112-0008**  
250mm (10")

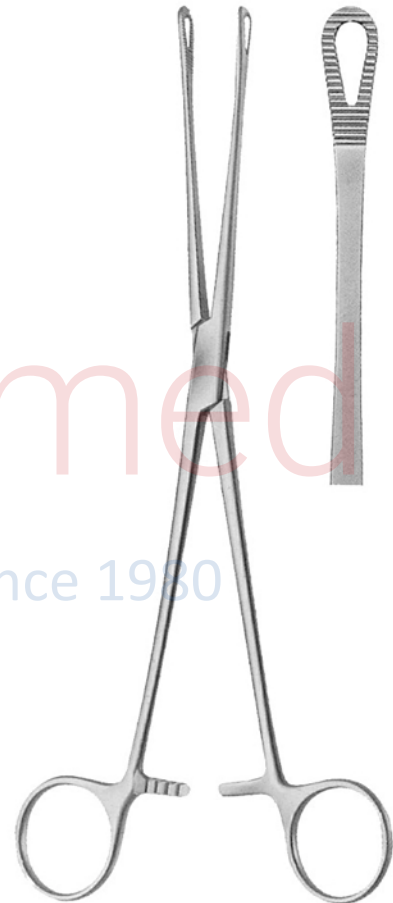

**BONNEY POLYPI**  
**112-0009**  
240mm (9.1/2")



S.S.Surgimed

World Class Instruments Since 1980

# SURGICAL INSTRUMENTS

## Cervical Biopsy Forceps ●●●

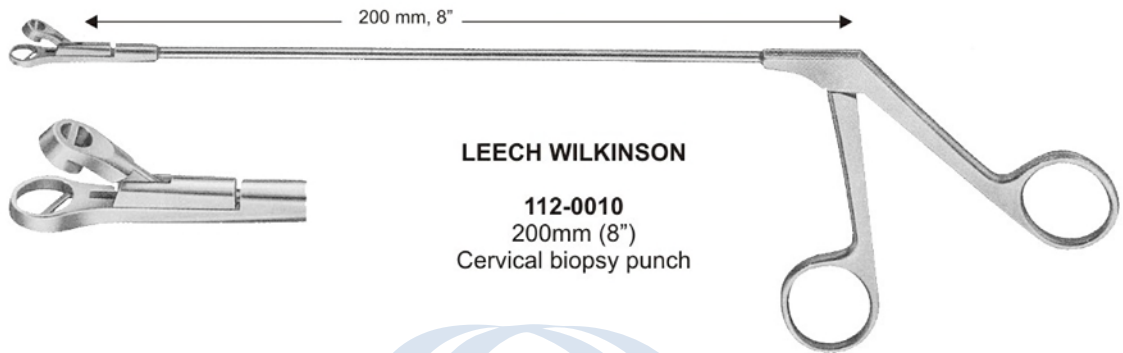

**LEECH WILKINSON**  
**112-0010**  
200mm (8")  
Cervical biopsy punch

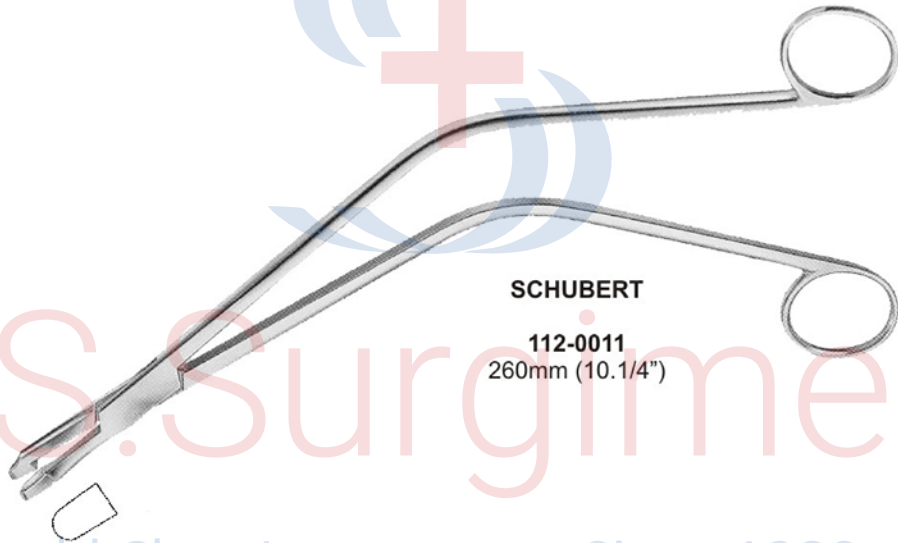

**SCHUBERT**  
**112-0011**  
260mm (10.1/4")

World Class Instruments Since 1980

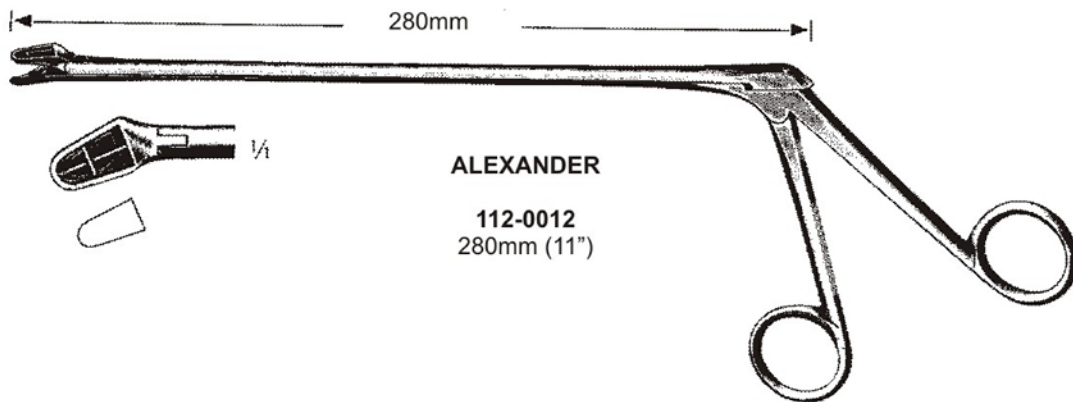

**ALEXANDER**  
**112-0012**  
280mm (11")

## ●●● Cervical Biopsy Forceps



240mm

**SCHUMARCHER**

**112-0013**  
240mm (9.1/2")



235mm

**KEVORKIAN**

**112-0014**  
235mm (9.3/4")



230mm

**WITTNER**

**112-0015**  
230mm (9.1/4") Straight  
230mm (9.1/4") Curved



200mm

**TISCHLER-MORGAN**

**112-0016**  
200mm (8")





S.S. Surgimed

World Class Instruments Since 1980

# SURGICAL INSTRUMENTS

## Uterine Scoops And Curettes ●●●

The image displays three main types of uterine scoops and curettes, each with a full-length illustration and several smaller diagrams of the scooped ends. The instruments are arranged in three columns.

- Simon Instruments:**
  - 112-0017: 6.8mm
  - 112-0018: 8.5mm
  - 112-0019: 10mm
  - 112-0020: 11.5mm
  - 112-0021: 13mm
  - 112-0022: 14.5mm
- Sims Instruments (Rigid, sharp):**
  - 112-0023: 7.5mm
  - 112-0024: 8.5mm
  - 112-0025: 10.5mm
  - 112-0026: 12mm
  - 112-0027: 14mm
  - 112-0028: 15mm
- Sims Instruments (Malleable, Sharp):**
  - 112-0029: 7.5mm
  - 112-0030: 8.5mm
  - 112-0031: 10.5mm
  - 112-0032: 12mm
  - 112-0033: 14mm
  - 112-0034: 15mm

**SIMON**  
240mm (9.1/2")

**SIMS**  
255mm (10")  
Rigid, sharp

**SIMS**  
255mm (10")  
Malleable, Sharp



## ●●● Uterine Curettes

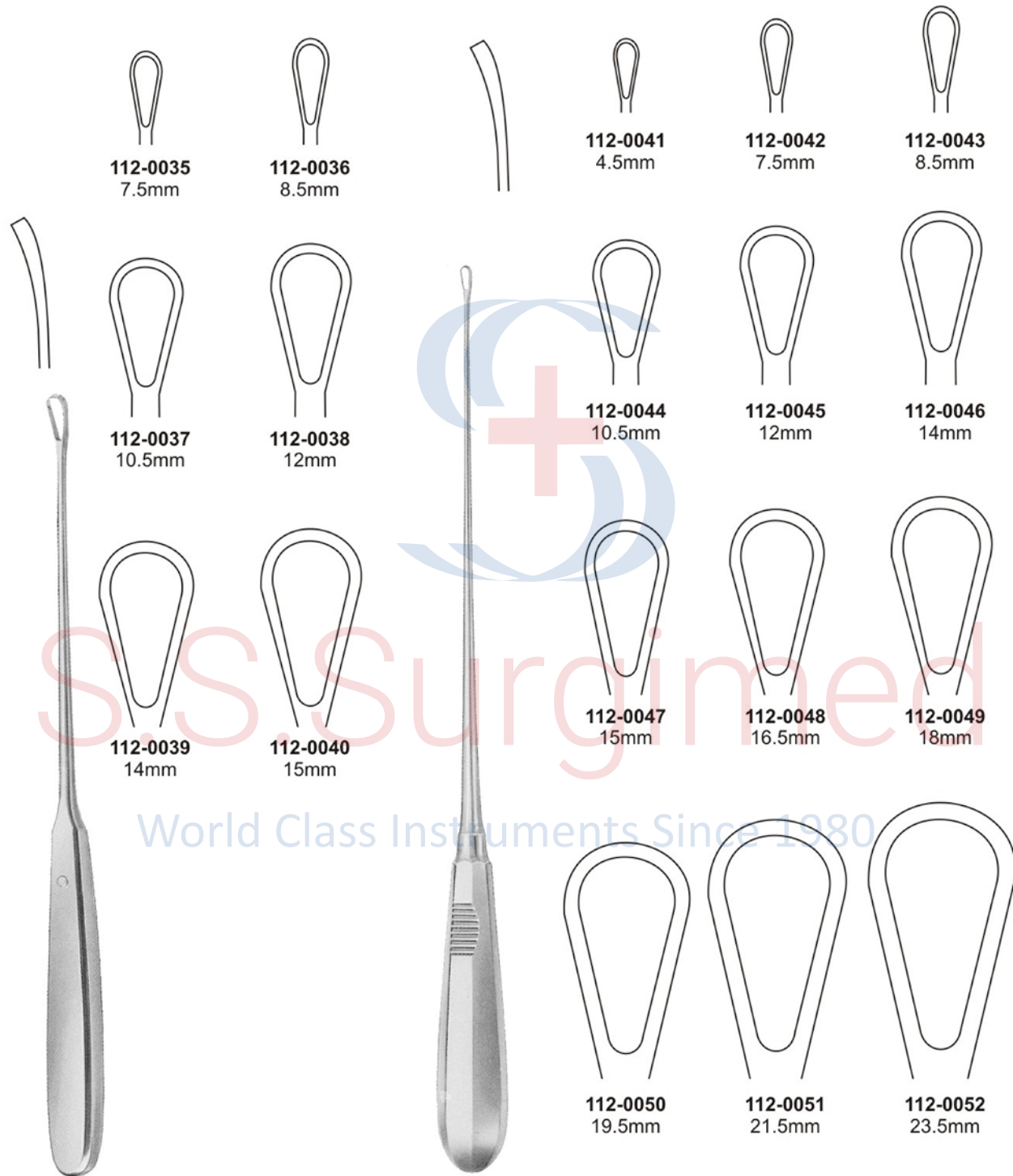

**SIMS**  
255mm (10")  
Malleable, blunt

300mm (12")  
Sharp



S.S.Surgimed

World Class Instruments Since 1980

# SURGICAL INSTRUMENTS

## Uterine Cannulae ●●●

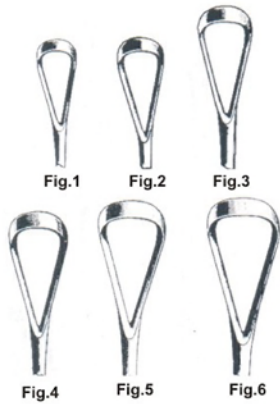

**SIMS**  
112-0053  
280mm (11")



**RECAMIER**  
112-0054  
310mm (13")

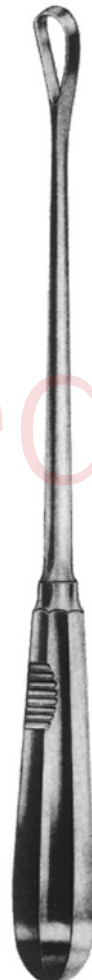

**BUMM**  
112-0055  
280mm (11")

S.S. Surgimed  
World Class Instruments Since 1980

## ●●● Obstetrics Instruments

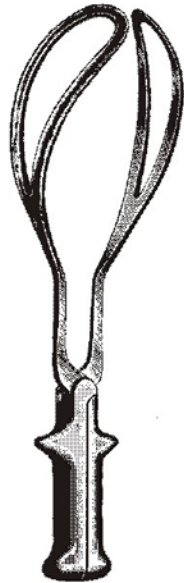

**SIMPSON**  
112-0056 300mm  
(12")

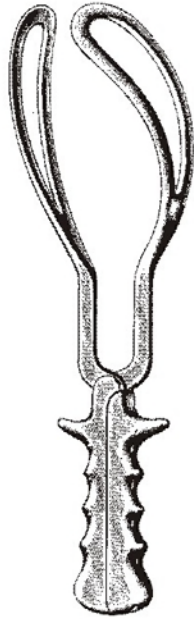

**SIMPSON-BRAUN**  
112-0057 330mm  
(13")



**De LEE**  
112-0058 300mm  
(12")



**De LEE**  
112-0059 360mm  
(14.1/2")

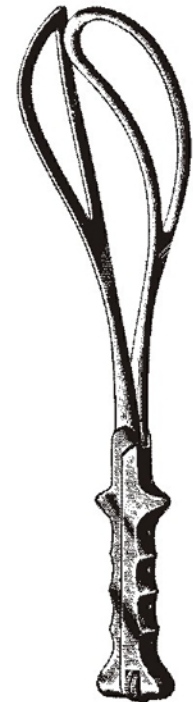

**ELLIOT**  
112-0060 320mm  
(12.1/2")

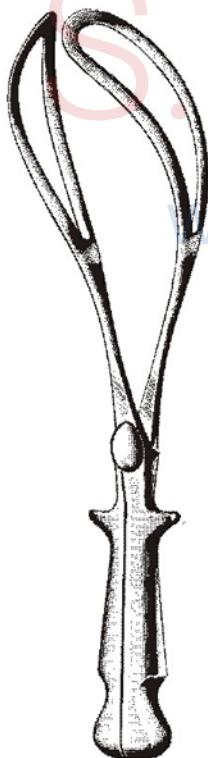

**NAEGELE**  
112-0061  
360mm (14.1/2")



**I.U.D. REMOVING HOOK**  
112-0062 320mm (12.1/2")

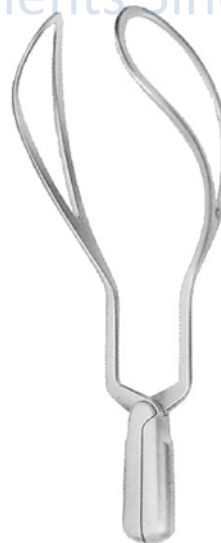

**WRIGLEY**  
112-0063 250mm (10")



**KIELLAND**  
112-0064 402mm (16.3/4")





S.S. Surgimed

World Class Instruments Since 1980

# SURGICAL INSTRUMENTS

## Obstetrics Instruments ●●●

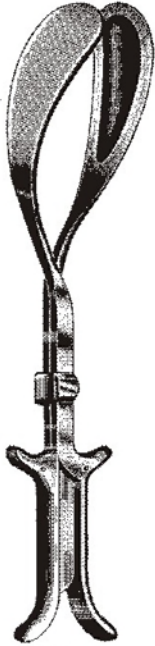

LUIKART

112-0065  
400mm (16")



KIELLAND-LUIKART

112-0066  
400mm (16")



SIMPSON-LUIKART

112-0067  
360mm (14.1/2")

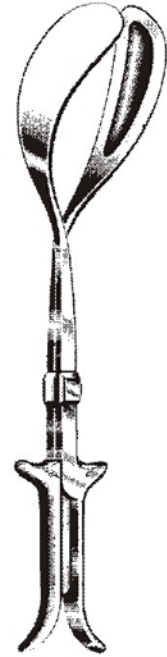

McLEAN-TUCKER-LUIKART

112-0068  
400mm (16")

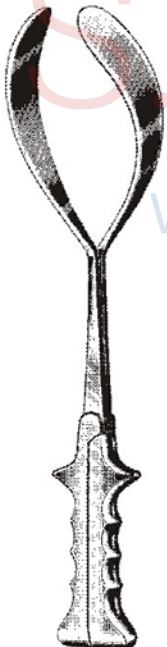

McLEAN-TUCKER

112-0069  
390mm (15.1/2")

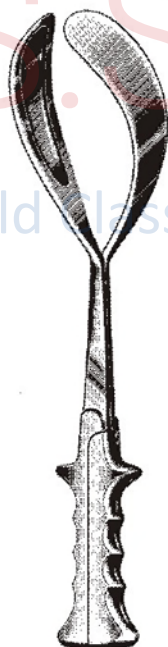

McLEAN-LUIKART

112-0070  
390mm (15.1/2")

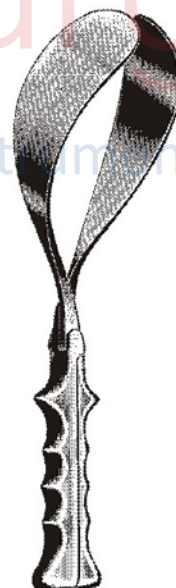

McLEAN

112-0071  
360mm (14.1/2")

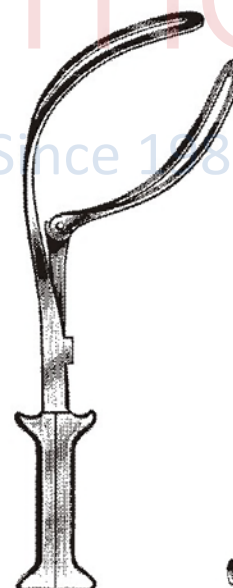

BARTON

112-0072  
360mm (14.1/2")

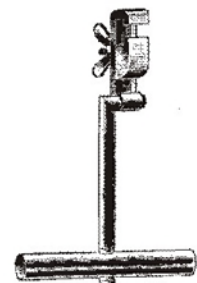

BARTON

112-0073  
170mm (6.3/4")



## ●●● Dermatology, Gynecology Instruments



**GREEN - ARMYTAGE  
HEAMOSTASIS FORCEPS**  
**113-0001**  
200mm (8") Straight  
**113-0002**  
195mm (7.3/4") Angled

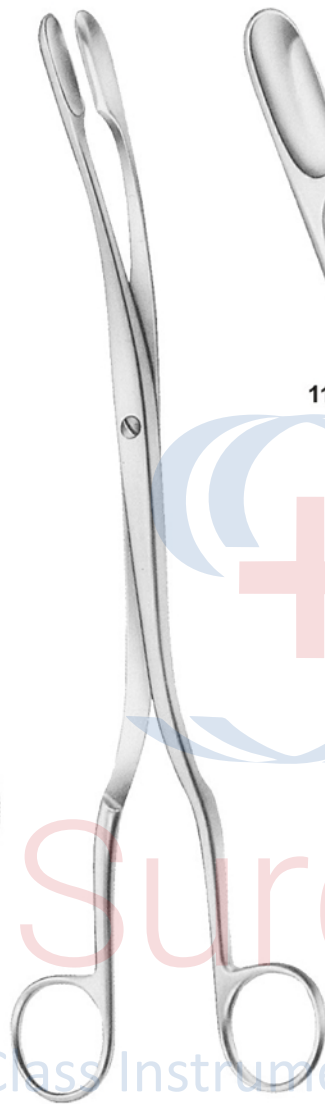

**WINTER OVUM FORCEPS**  
290mm (11.1/2")



**113-0003**



**113-0004**



**113-0005**



**SAENGER OVUM FORCEPS**  
**113-0006**  
275mm (10.3/4")



**UMBILICAL DILATOR**  
**113-0007**  
95mm (3.3/4")



S.S. Surgimed

World Class Instruments Since 1980

# SURGICAL INSTRUMENTS

## Peritoneum, Hysterectomy Clamps ●●●



113-0008

113-0009



**MIKULICZ**  
113-0008 180mm (7")  
113-0009 205mm (8")

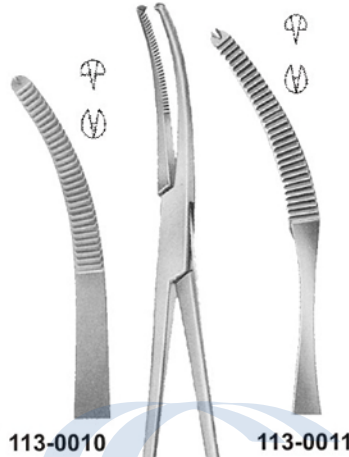

113-0010

113-0011

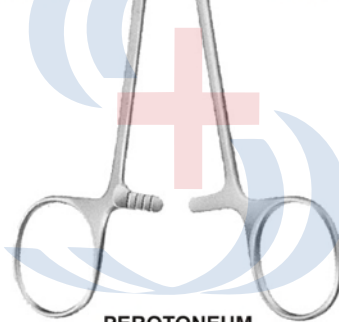

**PEROTONEUM**  
113-0010 205mm (8")  
113-0011 205mm (8")

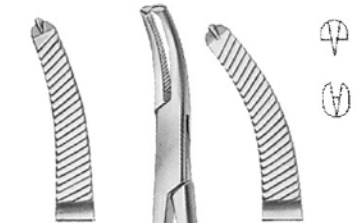

113-0012

113-0013



**FAURE**  
113-0012 205mm (8")  
113-0013 205mm (8")

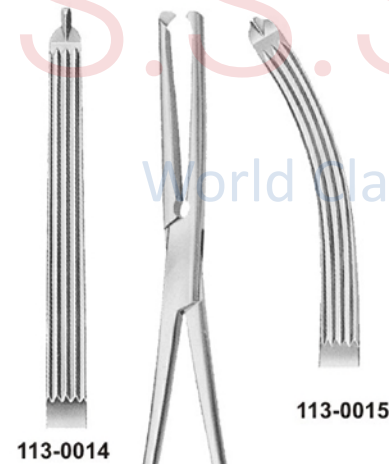

113-0014

113-0015



**GWILLIAM**  
**HYSTERECTOMY** 200mm (8")  
113-0014 Straight  
113-0015 Curved



113-0016



**HEANY**  
**HYSTERECTOMY FORCEPS** 200m (8")  
113-0016 Curved, single tooth

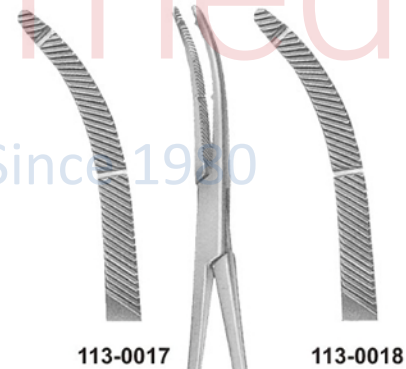

113-0017

113-0018



**HEANY**  
113-0017 205mm (8")  
113-0018 245cm (9.3/4")

## ●●● Hysterectomy Clamps



**MAINGOT  
GYSTERECTOMY FORCEPS**

**113-0019** 200mm (8")

Curved, 1 x 2 teeth

**113-0020**

Straight, 1 x 2 teeth

**113-0021** 240mm (9.1/2")

Curved, 1 x 2 teeth

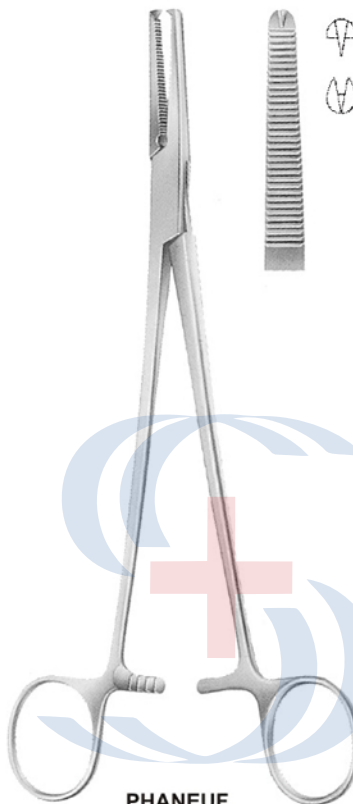

**PHANEUF**

**113-0022** 205mm (8")

Straight, 1 x 2 teeth



**BONNEY**

**113-0023** 205mm (8")

Angled on flat, 1 x 2 teeth

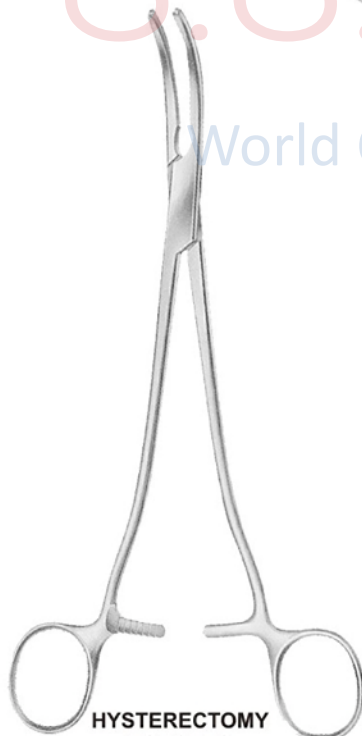

**HYSTERECTOMY  
FORCEPS**  
Atraumatic



**113-0024**  
215mm (8.1/2")

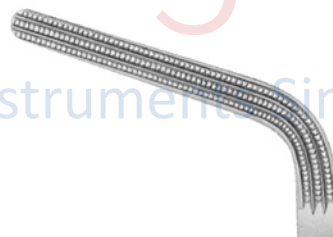

**113-0025**  
205mm (8")



**113-0026**  
220mm (8.3/4")



**113-0027**  
240mm (9.1/2")



**113-0028**  
225mm (9")



**113-0029**  
250mm (10")



**113-0030**  
245mm (9.3/4")

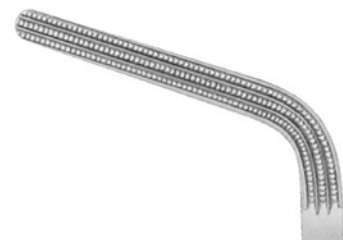

**113-0031**  
230mm (9")



S.S. Surgimed

World Class Instruments Since 1980

# SURGICAL INSTRUMENTS

## Proctology ●●●

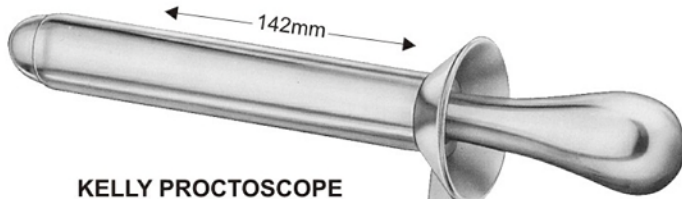

**KELLY PROCTOSCOPE**

**113-0032**  
140mm (5.1/2") Diameter, 22mm

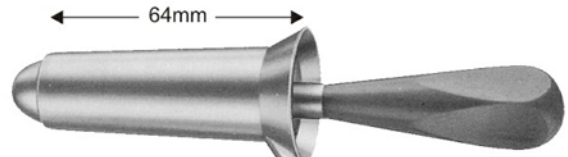

**GABRIEL RECTAL SPECULUM**

**113-0033**  
64mm (2.1/2")  
Diameter: 25mm



**MCEVEDY  
RECTAL SPECULUM  
WITH  
BATTERY HANDLE**  
**113-0034** 150mm (6")  
Diameter: 27mm

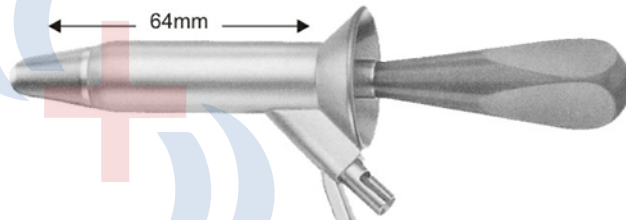

**NAUNTUN MORGAN  
RECTAL SPECULUM**

165mm (6.1/2")  
**113-0035**  
Diameter: 17mm  
With fibre light carrier  
**113-0036**  
Diameter: 21mm  
With fibre light carrier  
**113-0037**  
Diameter: 24mm  
With fibre light carrier

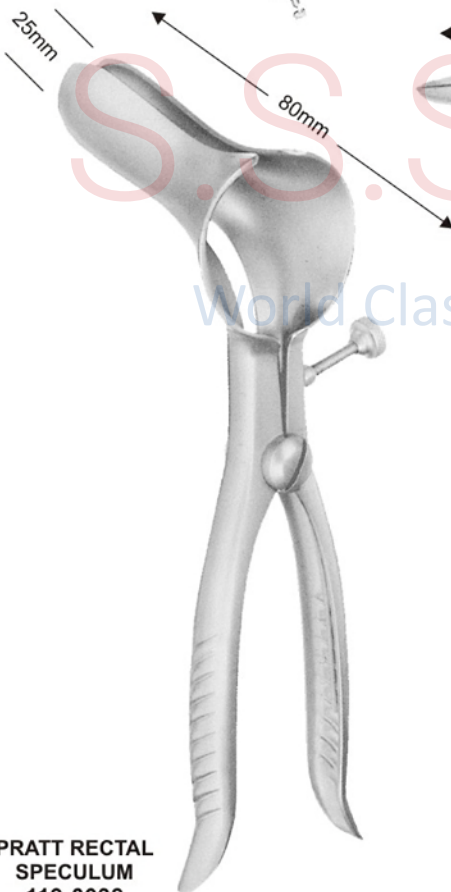

**PRATT RECTAL  
SPECULUM**  
**113-0038**  
205mm (8")



**CZERNY  
RECTAL SPECULUM**  
**113-0039**  
225mm (9")



**SIMS RECTAL  
SPECULUM**  
**113-0040**  
160mm (6.1/4")



●●● Urology

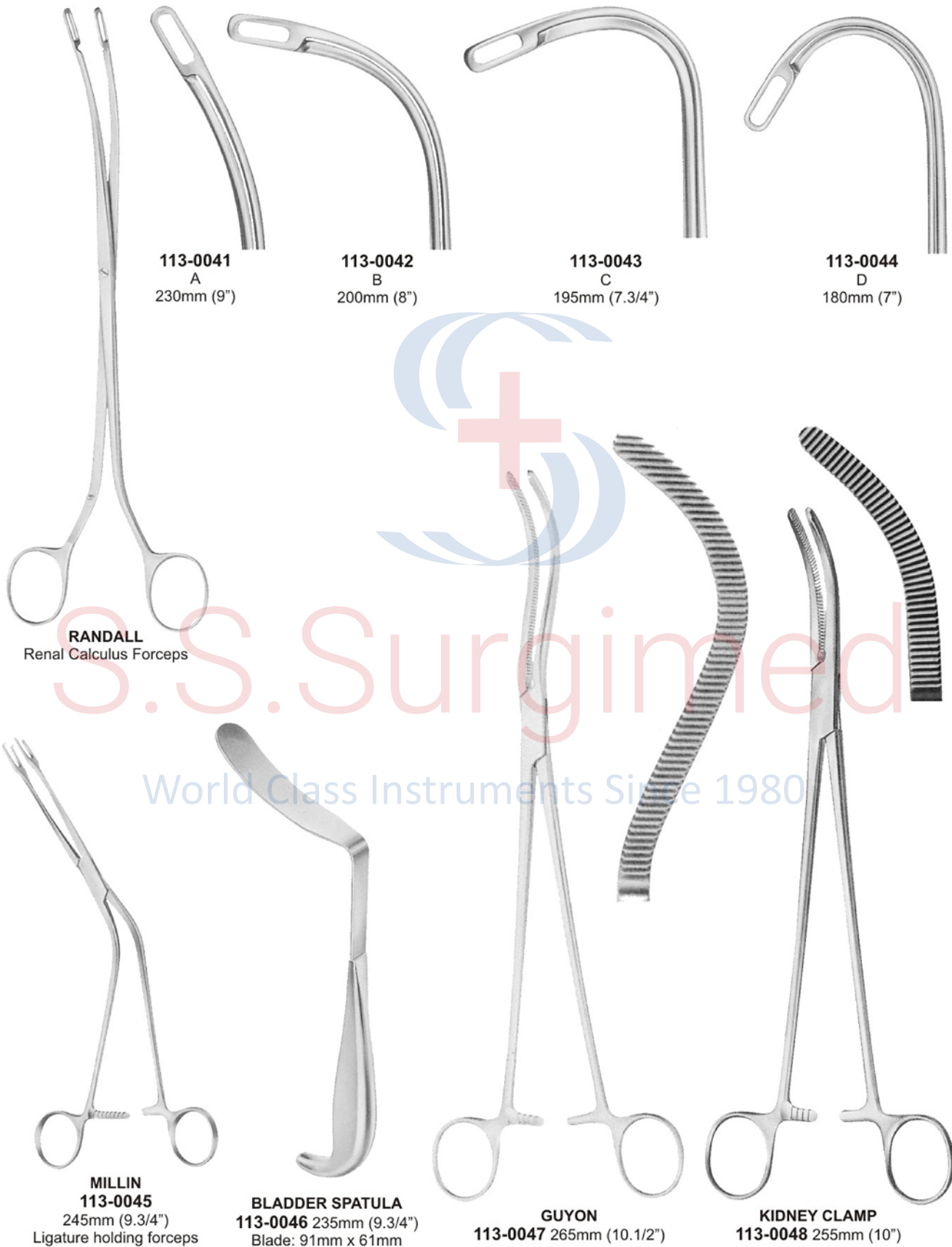



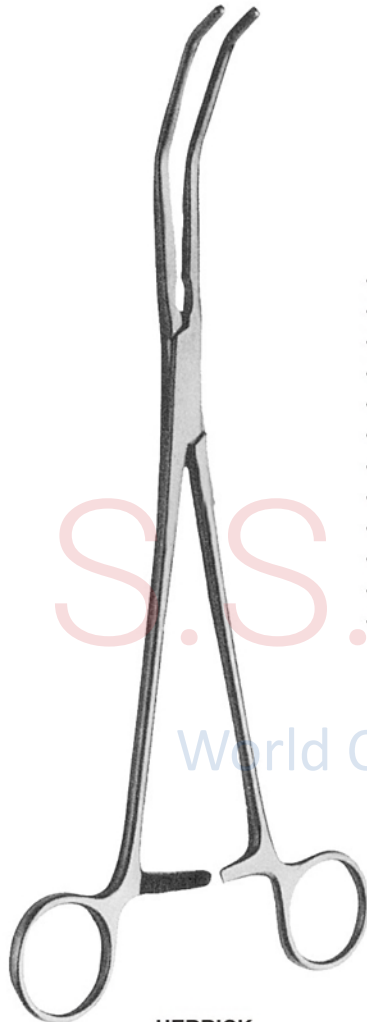

**HERRICK**  
113-0049 225mm (9")

- 113-0050 6/10 f.g (2/3.33mm)
- 113-0051 8/12 f.g (2.66/4.66mm)
- 113-0052 10/14 f.g (3.33/4.66mm)
- 113-0053 12/16 f.g (4/5.33mm)
- 113-0054 14/18 f.g (4.66/6mm)
- 113-0055 16/20 f.g (5.33/6.66mm)
- 113-0056 18/22 f.g (6/7.33mm)
- 113-0057 20/24 f.g (6.66/8mm)
- 113-0058 22/26 f.g (7.33/8.66mm)
- 113-0059 24/28 f.g (8/9.33mm)
- 113-0060 26/30 f.g (8.66/33mm)
- 113-0061 28/32 f.g (9.33/10.66mm)



**CLUTTON URETHRAL SOUNDS**  
265mm (10.1/2")  
Set twelve **113-0062**  
Set Comprising one of each of:

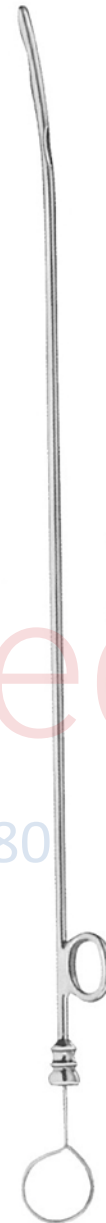

**FEMALE CATHETERS**  
160mm (6.1/4")

- 113-0062**  
12 f.g (4mm)
- 113-0063**  
8 f.g (2.66mm)
- 113-0064**  
10 f.g (3.33mm)
- 113-0065**  
14 f.g. (4.66mm)
- 113-0066**  
16 f.g. (5.33mm)

## ●●● Suction Tubes

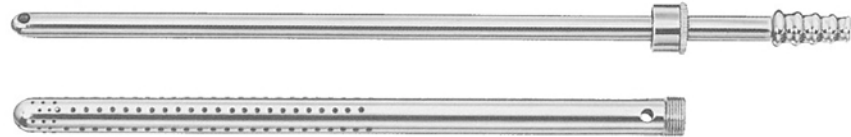

**POOLE**

**113-0069**  
240mm (9.1/2")

**113-0070**  
180mm (7")  
Lawrie extension piece



**YANKAUER**

**113-0067**  
305mm (12")

**113-0068**  
Rose end

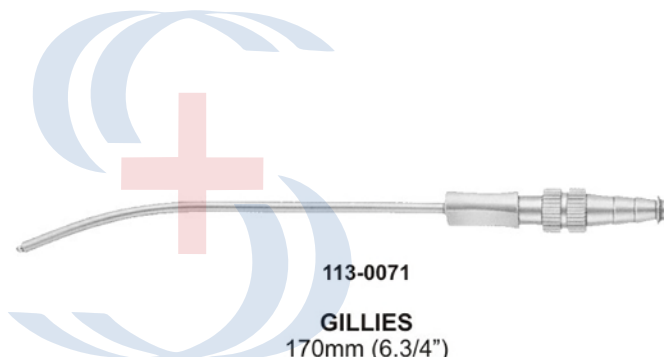

**113-0071**

**GILLIES**  
170mm (6.3/4")  
Control valve

S.S. Surgimed

World Class Instruments Since 1980

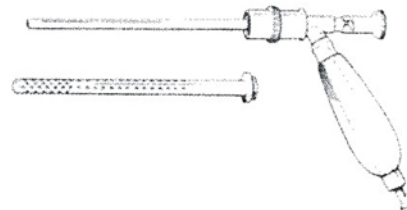

**TINCKLER**  
**(SIMPSON SMITH)**

**113-0072**  
255mm (10")

With on / off value, removable perforated outer sheath



**BARRON**  
**113-0073**  
230mm (9")  
Diameter: 1.33mm



**FRAZIER**  
**113-0074**  
185mm (7.1/4") Diameter 2.33mm 7.f.g  
**113-0075**  
185mm (7.1/4") Diameter 2.66mm 8 f.g  
**113-0076**  
185mm (7.1/4") Diameter 3mm 9.f.g

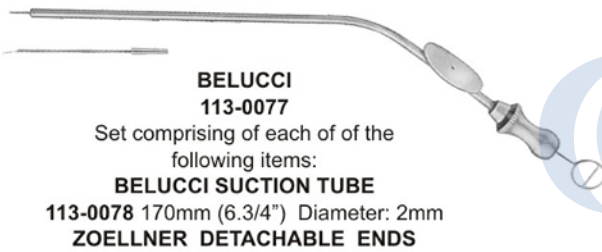

**BELUCCI**  
**113-0077**  
Set comprising of each of the following items:  
**BELUCCI SUCTION TUBE**  
**113-0078** 170mm (6.3/4") Diameter: 2mm  
**ZOELLNER DETACHABLE ENDS**

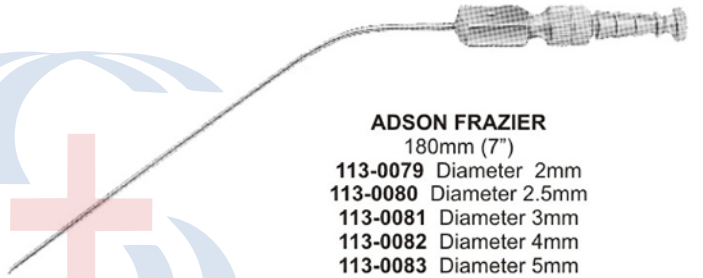

**ADSON FRAZIER**  
180mm (7")  
**113-0079** Diameter 2mm  
**113-0080** Diameter 2.5mm  
**113-0081** Diameter 3mm  
**113-0082** Diameter 4mm  
**113-0083** Diameter 5mm

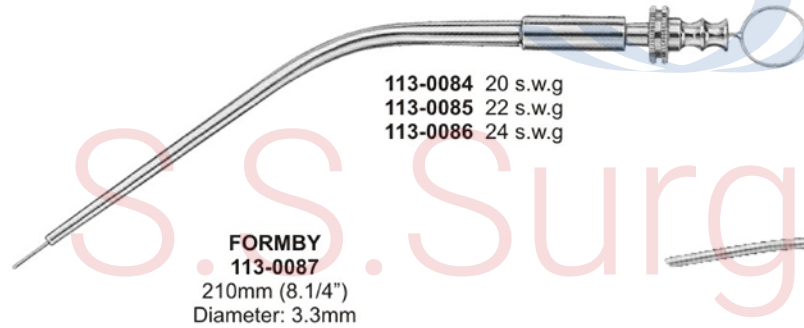

**FORMBY**  
**113-0087**  
210mm (8.1/4")  
Diameter: 3.3mm

**113-0084** 20 s.w.g  
**113-0085** 22 s.w.g  
**113-0086** 24 s.w.g



**ADSON**  
180mm (7")  
**113-0088** Diameter 3mm  
**113-0089** Diameter 5mm

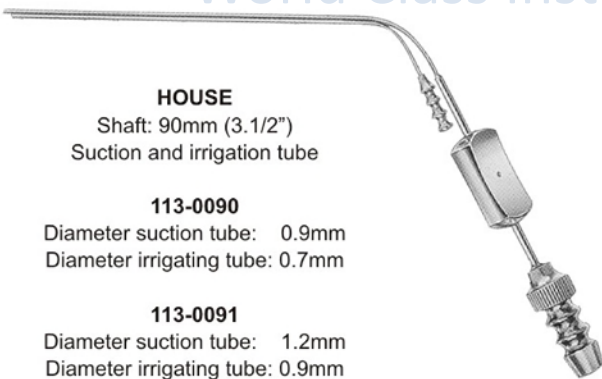

**HOUSE**  
Shaft: 90mm (3.1/2")  
Suction and irrigation tube  
**113-0090**  
Diameter suction tube: 0.9mm  
Diameter irrigating tube: 0.7mm  
**113-0091**  
Diameter suction tube: 1.2mm  
Diameter irrigating tube: 0.9mm



**CONE SUCTION TUBES**  
**113-0093**



**SUCTION TUBES**  
**113-0094** Diameter: 3mm  
**113-0095** Diameter: 4mm  
**113-0096** Diameter: 5mm

**HANDLE**  
**113-0097** 100mm (4")  
with Tucker valve



## ●●● Amputation Instruments



**PERCY AMPUTATION FLAP  
RETRACTOR**

**114-0001**  
Removable handles

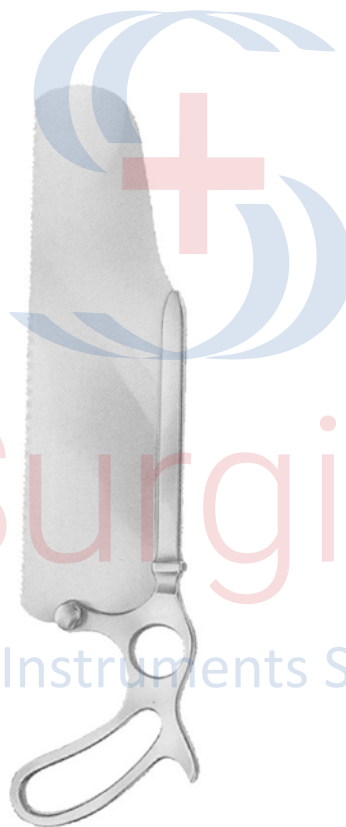

**AMPUTATION SAW**  
With hinged back  
to take apart

**114-0002**  
Blade: 230mm (9")

**114-0003**  
Spare blade for  
amputation saw



**FINGER SAW**

**114-0004**  
200mm (8")



**ARMY REGULATION  
AMPUTATION SAW**

**114-0005**  
Blade: 180mm (7")  
With hinged back  
to take apart



S.S. Surgimed

World Class Instruments Since 1980

# SURGICAL INSTRUMENTS

## Urology Bone Levers & Raspatories ●●●

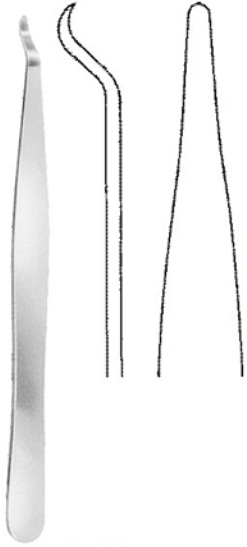

**115-0001**  
140mm (5.1/2")  
Width at tip 2.8mm



**115-0002**  
150mm (6")  
Width at tip 6mm

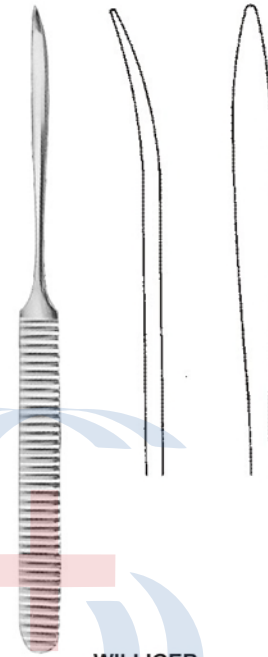

**WILLIGER**  
**115-0003**  
175mm (7")  
Width at tip 5.5mm

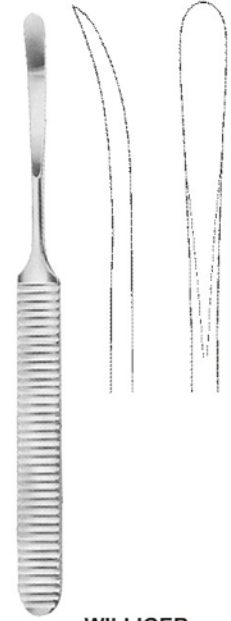

**WILLIGER**  
**115-0004**  
160mm (6.1/4")  
Width at tip 6.5mm

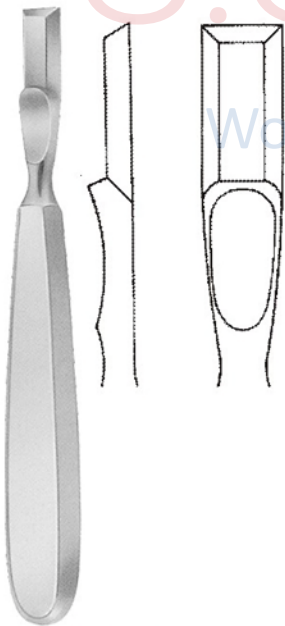

**FARABEUF**  
160mm (6.1/4")  
8mm wide  
**115-0005** Straight  
**115-0006** Curved

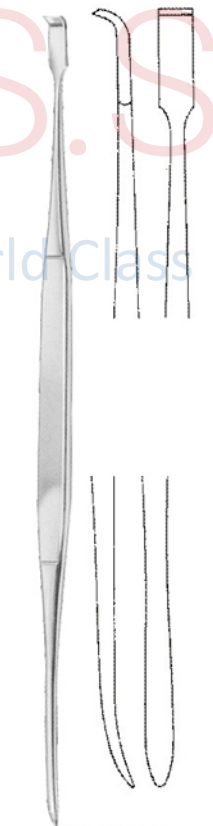

**HOWARTH**  
**115-0007** 230mm (9")

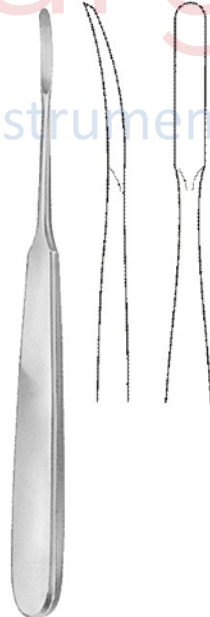

**JOSEPH**  
**115-0007**  
170mm (6.3/4")  
Width at tip: 4mm

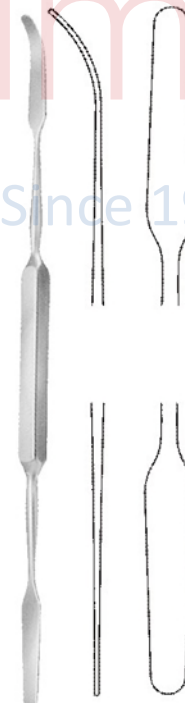

**MACDONALD**  
**115-0008**  
185mm (7.1/4") blunt

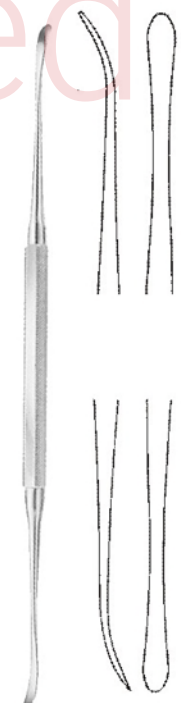

**FREER ELEVATOR**  
**115-0009**  
190mm (7.1/2"),  
double ended





## ●●● Bone Levers & Raspatories



**ADSON**  
165mm (6.1/2"), curved  
115-0010 width 5mm  
115-0011 width 7mm



**ADSON**  
165mm (6.1/2") slight curve  
115-0012 Width 7mm



**PENNYBACKER**  
150mm (6")  
115-0013  
Width 6mm



**VOLKMANN**  
170mm (6.3/4")

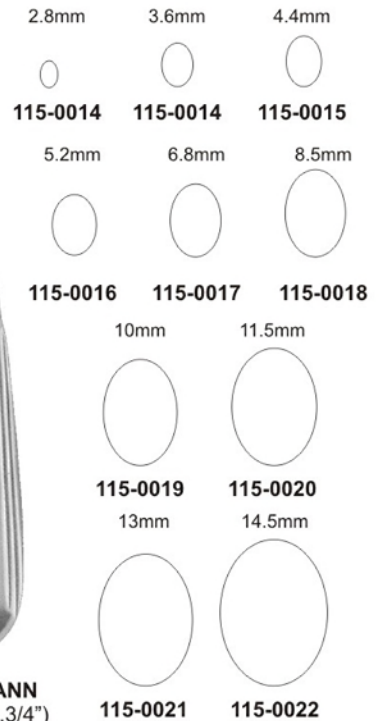

S.S. Surgimed

World Class Instruments Since 1980

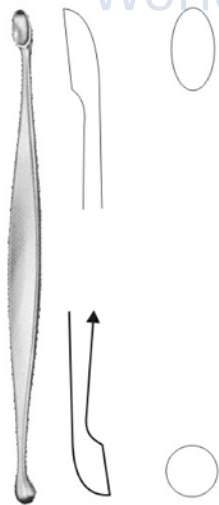

**BOYD BONE CURETTE**  
Oval, double ended  
115-0023 130mm (5.1/8")

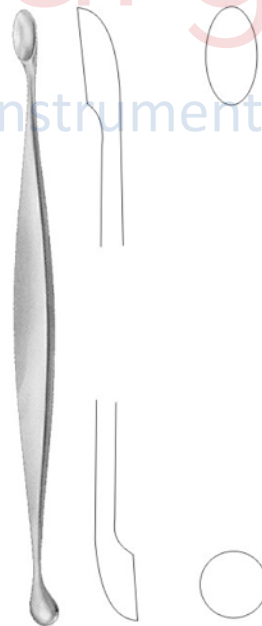

**BOYD BONE CURETTE**  
Oval, double ended  
115-0024 160mm (6.1/4")



**BOYD BONE CURETTE**  
Oval, double ended  
115-0025 200mm (8")



S.S. Surgimed

World Class Instruments Since 1980

# SURGICAL INSTRUMENTS

## Bone Scoops ●●●



**VOLKMANN**  
Double ended  
**115-0026**  
130mm (5.1/8")  
**115-0027**  
140mm (5.1/2")  
**115-0028**  
170mm (6.3/4")



**MACEWEN**  
180mm (7")  
Combined  
with seeker  
**115-0029**  
Oval  
**115-0030**  
Round

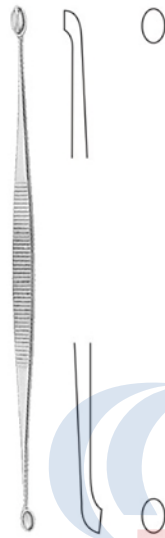

**JACOBSON**  
**115-0031**  
140mm (5.1/2")

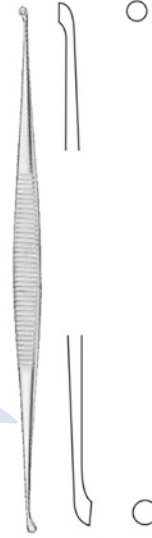

**MARTINI**  
**115-0032**  
140mm (5.1/2")



**MARTINI**  
**115-0033**  
140mm (5.1/2")

**115-0034**  
2mm x 3.5mm

**115-0035**  
2mm x 4mm

**115-0036**  
2.5mm 4.5mm

**115-0037**  
2.75mm x 5mm

**115-0038**  
3mm x 5.5mm

**115-0039**  
3.25mm x 6mm

**115-0040**  
2mm x 3mm

**115-0041**  
3mm x 4mm

**115-0042**  
4mm x 5mm

**115-0043**  
5mm x 6mm



**LEMPERT**  
200mm (8")\*



**COLLIER AND MORRIS**  
180mm (7")

## ●●● Mallets, Bone Holding Forceps



**LUCAE**  
**116-0001**  
Diameter: 27mm  
8.1/2 oz



**KELSEY FRY**  
**116-0002** 190mm (7.1/2")  
Diameter: 20mm  
**SPARE DISKS**  
**116-0003** Spare disks for  
Kelsey-Fry Mallet



**HEATH**  
**116-0004**  
Diameter: 25mm 28 oz  
**116-0005**  
Diameter: 40mm 36 oz



**SEQUESTUM**  
**FORCEPS**  
**116-0006**  
190mm (7.1/2")  
Straight



**SEQUESTUM**  
**FORCEPS**  
**116-0007**  
190mm (7.1/2")  
Angled



**FERGUSSON**  
**116-0008**  
200mm (8")



S.S. Surgimed

World Class Instruments Since 1980

# SURGICAL INSTRUMENTS

## Bone Holding Forceps ●●●

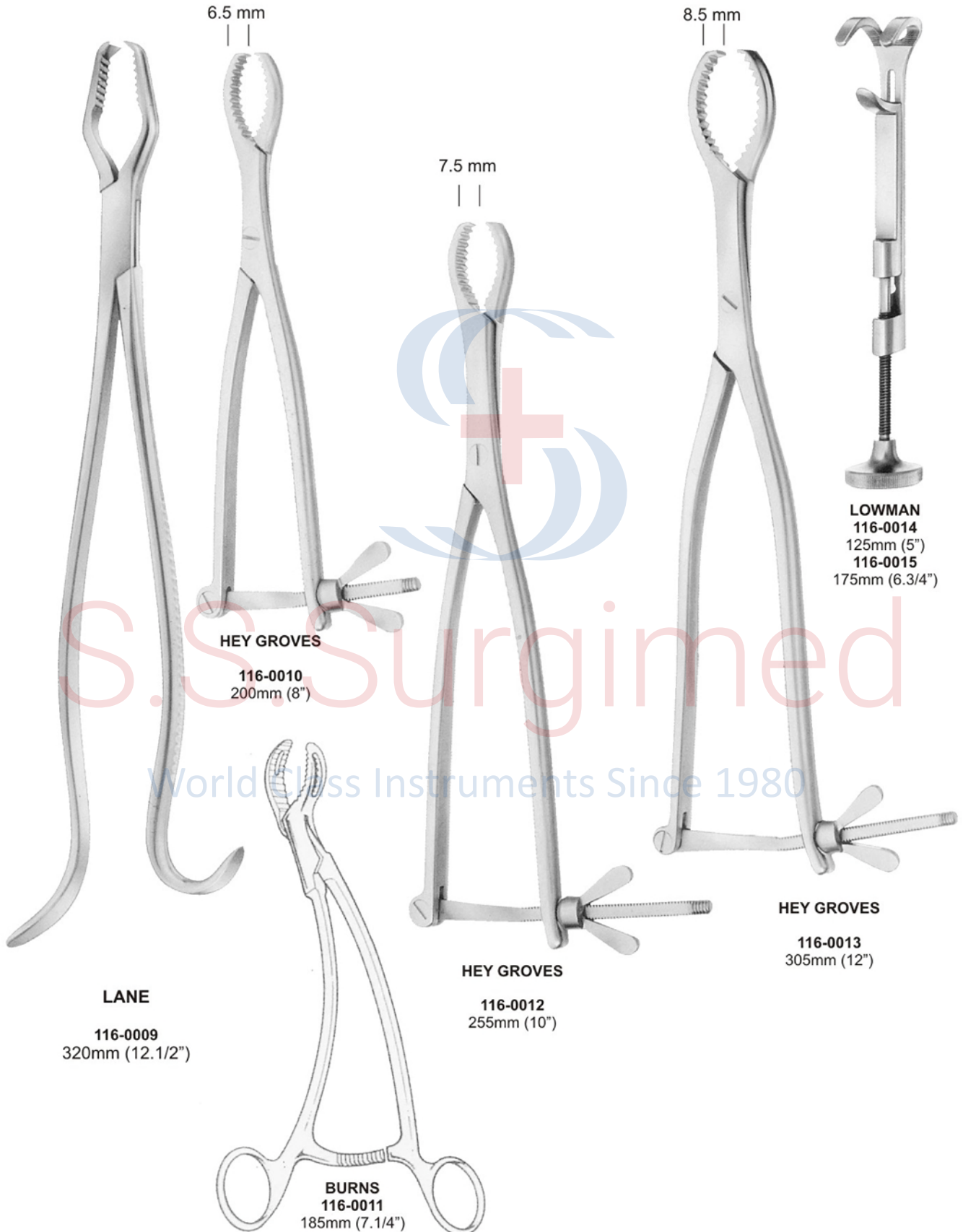

6.5 mm

8.5 mm

7.5 mm

**HEY GROVES**

**116-0010**  
200mm (8")

**LANE**

**116-0009**  
320mm (12.1/2")

**BURNS**  
**116-0011**

185mm (7.1/4")

**HEY GROVES**

**116-0012**  
255mm (10")

**HEY GROVES**

**116-0013**  
305mm (12")

**LOWMAN**  
**116-0014**  
125mm (5")  
**116-0015**  
175mm (6.3/4")



## ●●● Bone Holding Forceps



**116-0016**  
250mm (9.3/4")



**116-0017**  
255mm (10")

5mm



**116-0019**  
175mm (7")



**LEWIN**  
**116-0020**  
135mm (5.1/4")



**116-0018**  
265mm (10.1/2")

VERBRUGGE

VERBRUGGE

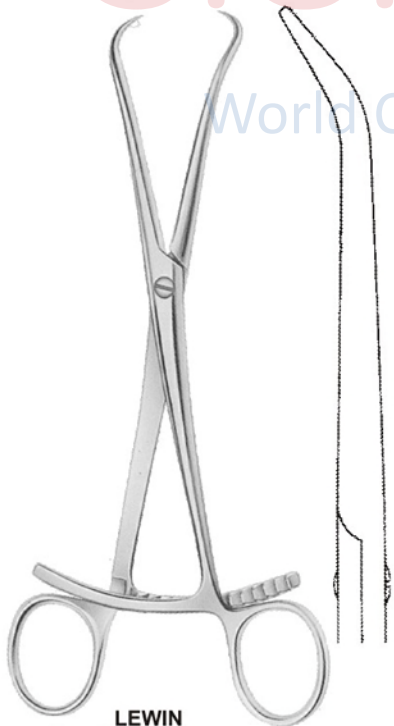

**LEWIN**  
**116-0021** 205mm (8")



**116-0022**  
190mm (7.1/2")  
Light pattern

**116-0023**  
190mm (7.1/2")  
Heavy pattern

DINGMAN

8mm



**SEMB**  
**116-0024**  
190mm (7.1/2")





S.S. Surgimed

World Class Instruments Since 1980

# SURGICAL INSTRUMENTS

## Bone Rongeurs ●●●



**BEYER**  
117-0001  
150mm (6")  
5mm bite



**JANSEN-MIDDLETON  
SEPTUM FORCEPS**  
117-0002  
200mm (8") Spoon shaped  
4mm bite



**CAIRNS**  
117-0003  
140mm (5.1/2")  
4mm bite



**CAIRNS**  
117-0004  
140mm (5.1/2")  
4mm bite



**LUER**  
117-0005  
155mm (6")

# S.S. Surgimed

World Class Instruments Since 1980



**RUSKIN**  
117-0006  
190mm (7.1/2")  
6mm bite



**HARTMANN**  
117-0007  
180mm (7")

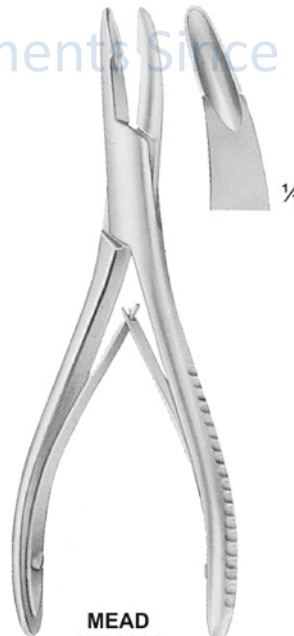

**MEAD**  
117-0008  
165mm (6.1/2")



**JANSEN**  
117-0009  
150mm (6")

## ●●● Bone Rongeurs



**TROTTER**

117-0010  
200mm (8")  
10mm bite

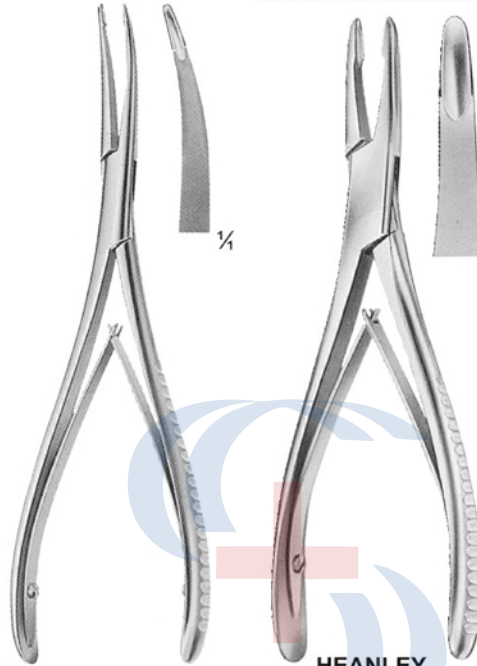

**SYNOVECTOMY  
RONGEUR**  
117-0011  
175mm (7")

**HEANLEY**

117-0012  
175mm (7")  
4mm bite



**PENNYBACKER**

117-0013  
200mm (8")  
4mm bite



**SYNOVECTOMY  
RONGEUR**  
117-0014  
130mm (5.1/8")  
Jaw width 2mm



**NORTHFIELD**

117-0015  
200mm (8")  
10mm bite



**WILMS**

117-0016  
200mm (8")  
4mm bite

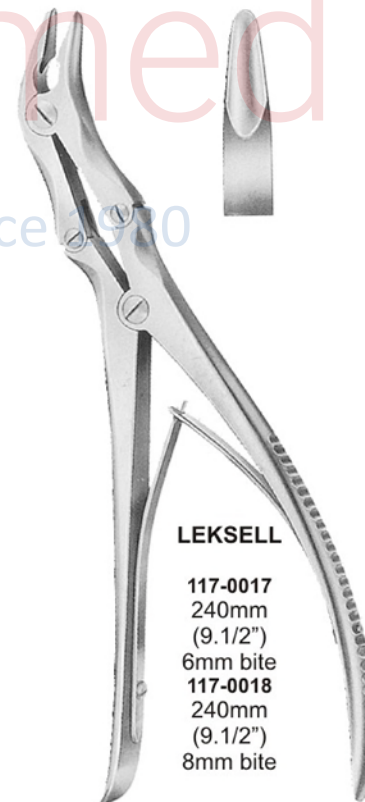

**LEKSELL**

117-0017  
240mm  
(9.1/2")  
6mm bite  
117-0018  
240mm  
(9.1/2")  
8mm bite



S.S. Surgimed

World Class Instruments Since 1980

# SURGICAL INSTRUMENTS

## Bone Rongeurs ●●●



**LUER-JANSEN**  
117-0019  
170mm (6.3/4")  
4mm bite



**BEYER**  
117-0020  
180mm (7")

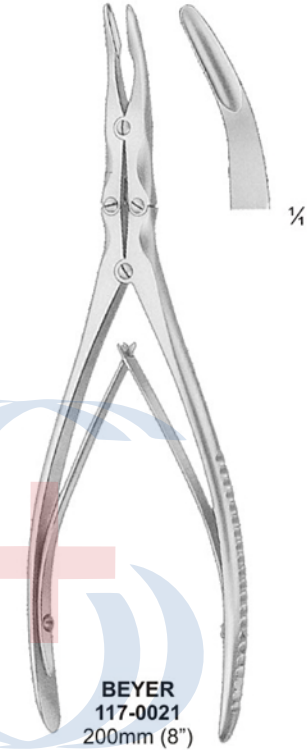

**BEYER**  
117-0021  
200mm (8")



**KILLEARN**  
117-0022  
197mm (7.3/4")  
3mm bite



**ZAUFAL-JANSEN**  
117-0023  
240mm (9.1/2")



**ECHLIN**  
117-0024  
240mm (9.1/2")



**NORTHFIELD**  
117-0025  
225mm (9") 10mm bite

## ●●● Bone Rongeurs



**SARGENT (VAN HAVRE)**  
117-0026  
220mm (8.3/4")  
10mm bite



**OLIVECRONA**  
117-0027  
230mm (9")  
6mm bite



**STILLE-RUSKIN**  
117-0028  
240mm (9.1/2")

World Class Instruments Since 1980

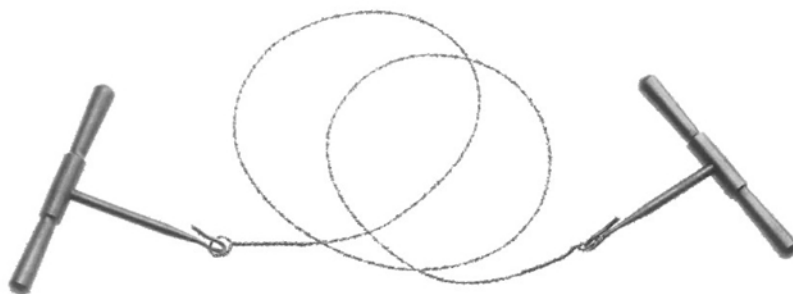

**GIGLI SAW WITH HANDLE**

117-0029  
500mm (20")



**RUDOR EDWARDS COSTOTOME**

117-0030  
230mm (9")



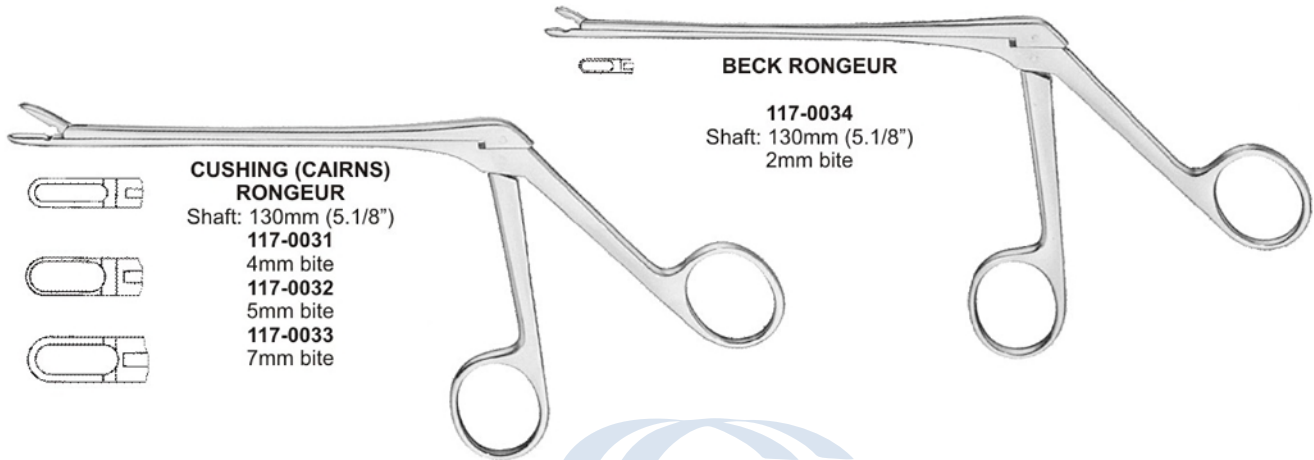

**BECK RONGEUR**  
117-0034  
Shaft: 130mm (5.1/8")  
2mm bite

**CUSHING (CAIRNS) RONGEUR**  
Shaft: 130mm (5.1/8")  
117-0031  
4mm bite  
117-0032  
5mm bite  
117-0033  
7mm bite

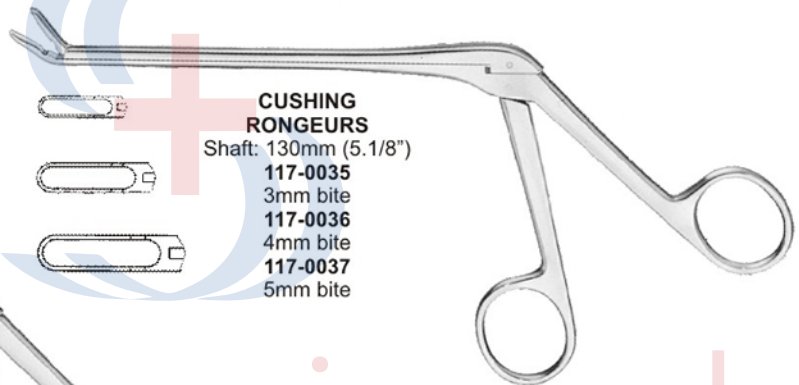

**CUSHING RONGEURS**  
Shaft: 130mm (5.1/8")  
117-0035  
3mm bite  
117-0036  
4mm bite  
117-0037  
5mm bite

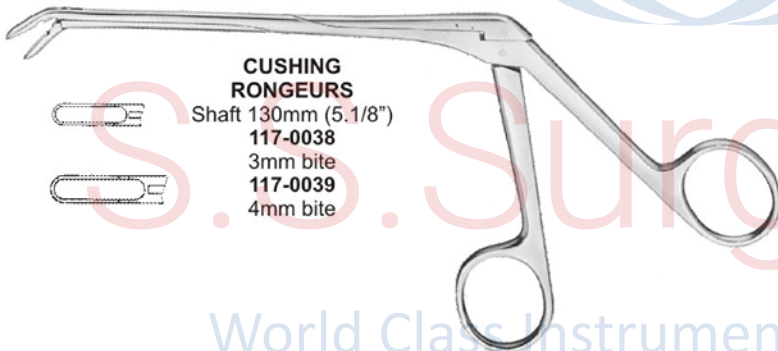

**CUSHING RONGEURS**  
Shaft 130mm (5.1/8")  
117-0038  
3mm bite  
117-0039  
4mm bite



**117-0040**  
Shaft: 180mm (7")  
10mm bite

**117-0041**  
Shaft: 180mm (7")  
10mm bite

World Class Instruments Since 1980



## ●●● Bone Cutting Forceps

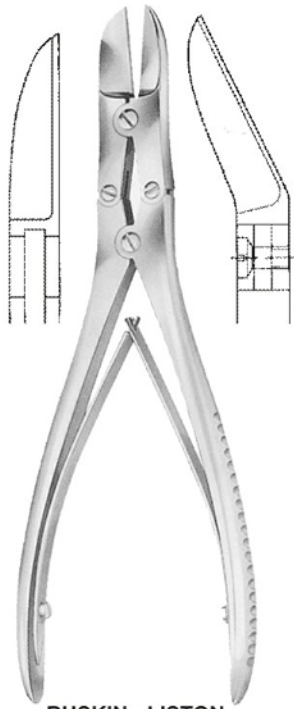

**RUSKIN - LISTON**  
 117-0042 190mm (7.1/2")  
 Straight  
 117-0043 190mm (7.1/2")  
 Angled on flat



**WARD**  
 117-0044  
 170mm (6.3/4")



**117-0045**  
 145mm (5.3/4")



**117-0046**  
 150mm (6")



**DE VILBISS**  
 117-0047  
 210mm (8.1/4")



**LISTON**  
**(TUDOR EDWARDS)**  
 117-0048  
 265mm (10.1/2")

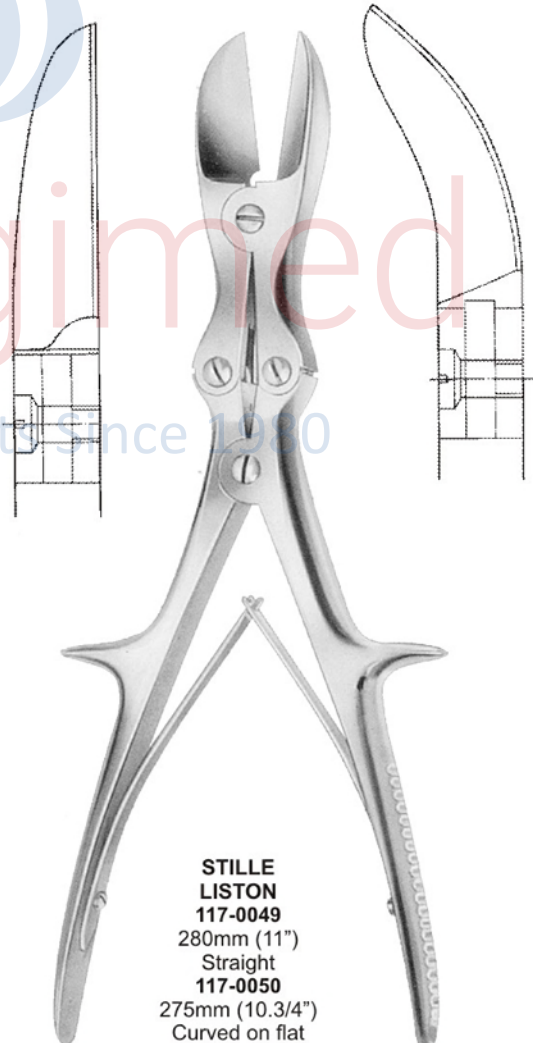

**STILLE**  
**LISTON**  
 117-0049  
 280mm (11")  
 Straight  
 117-0050  
 275mm (10.3/4")  
 Curved on flat



S.S. Surgimed

World Class Instruments Since 1980

# SURGICAL INSTRUMENTS

## Plaster Cast Removal Instruments ●●●



**PLASTER SHEARS**

**118-0001**  
160mm (6.1/4")

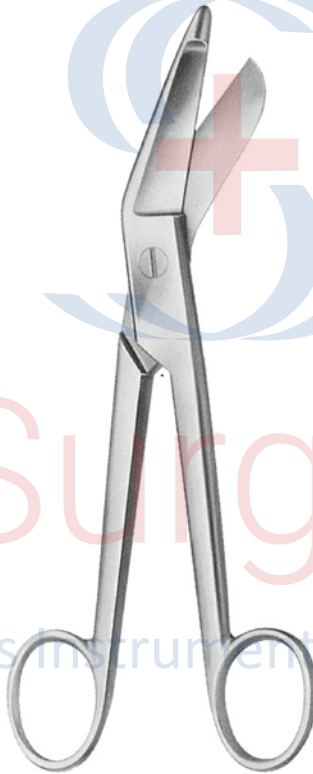

**PLASTER SHEARS**

**118-0002**  
200mm (8")

**118-0003**  
230mm (9")



**PLASTER SHEARS**

**118-0004**  
235mm (9.1/4")



## ●●● Rib Spreaders

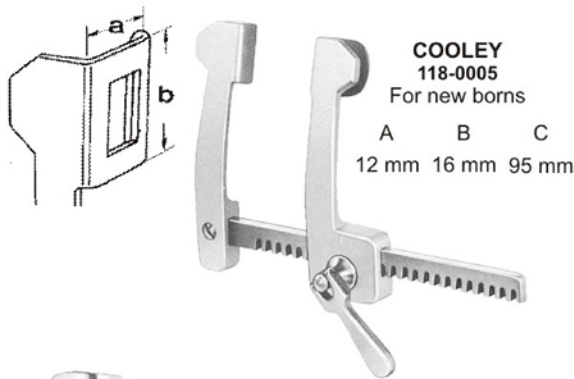

**COOLEY**  
118-0005  
For new borns

A	B	C
12 mm	16 mm	95 mm

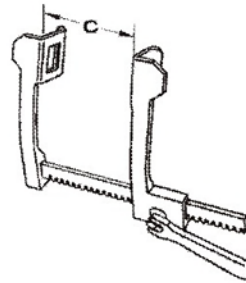

**COOLEY**

118-0006  
Pediatric size

A	B	C
15 mm	30 mm	140 mm
21 mm	44 mm	150 mm



**COOLEY**

118-0007  
For adults

A	B	C
35 mm	50 mm	200 mm



**FINOCCHIETTO - INFANT**

118-0008  
For babies

a	b	c
15mm	15mm	75mm

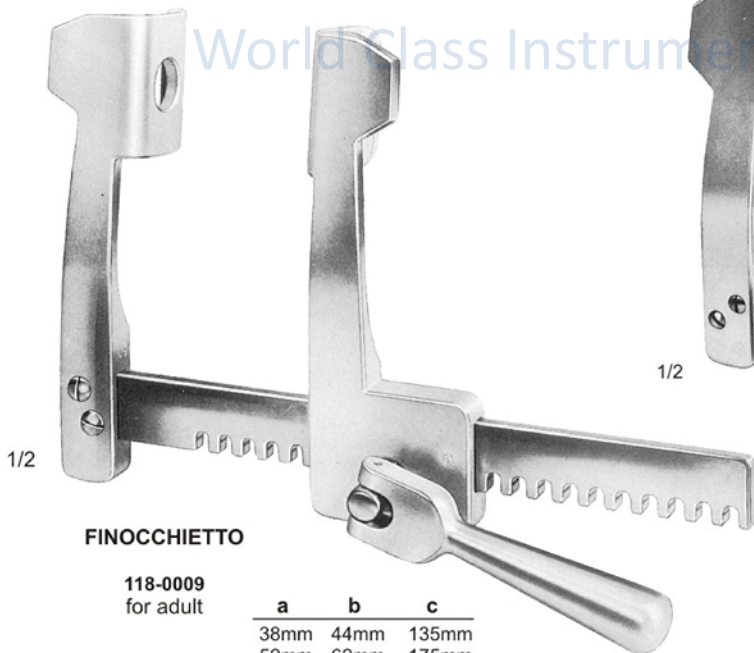

**FINOCCHIETTO**

118-0009  
for adult

a	b	c
38mm	44mm	135mm
52mm	62mm	175mm
85mm	65mm	175mm

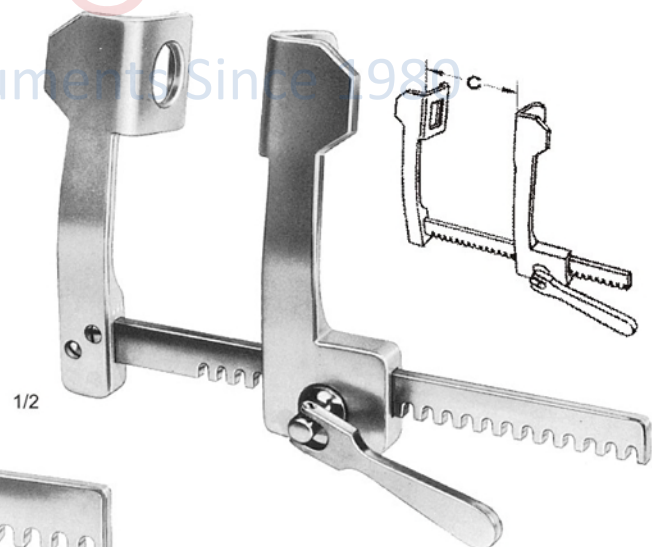

**FINOCCHIETTO-BABY**

118-0010  
Child size

a	b	c
31mm	31mm	100mm



S.S. Surgimed

World Class Instruments Since 1980

# SURGICAL INSTRUMENTS

## Rib Spreaders ●●●

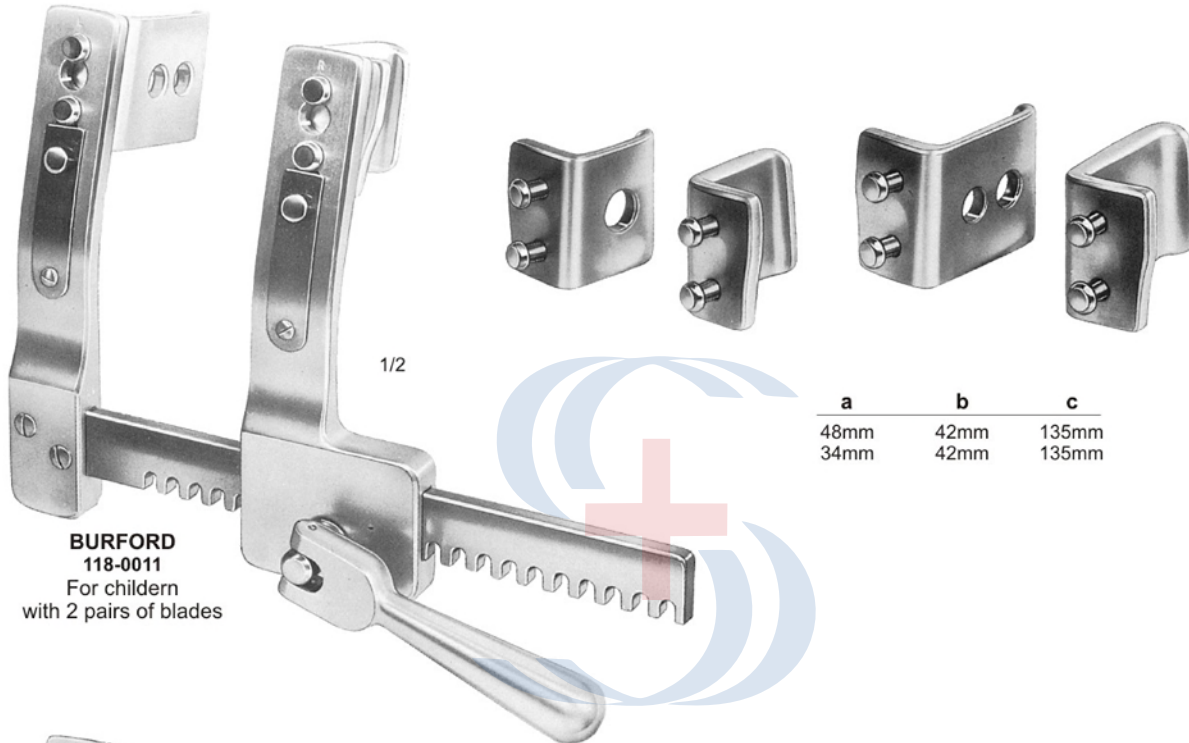

**BURFORD**  
118-0011  
For children  
with 2 pairs of blades

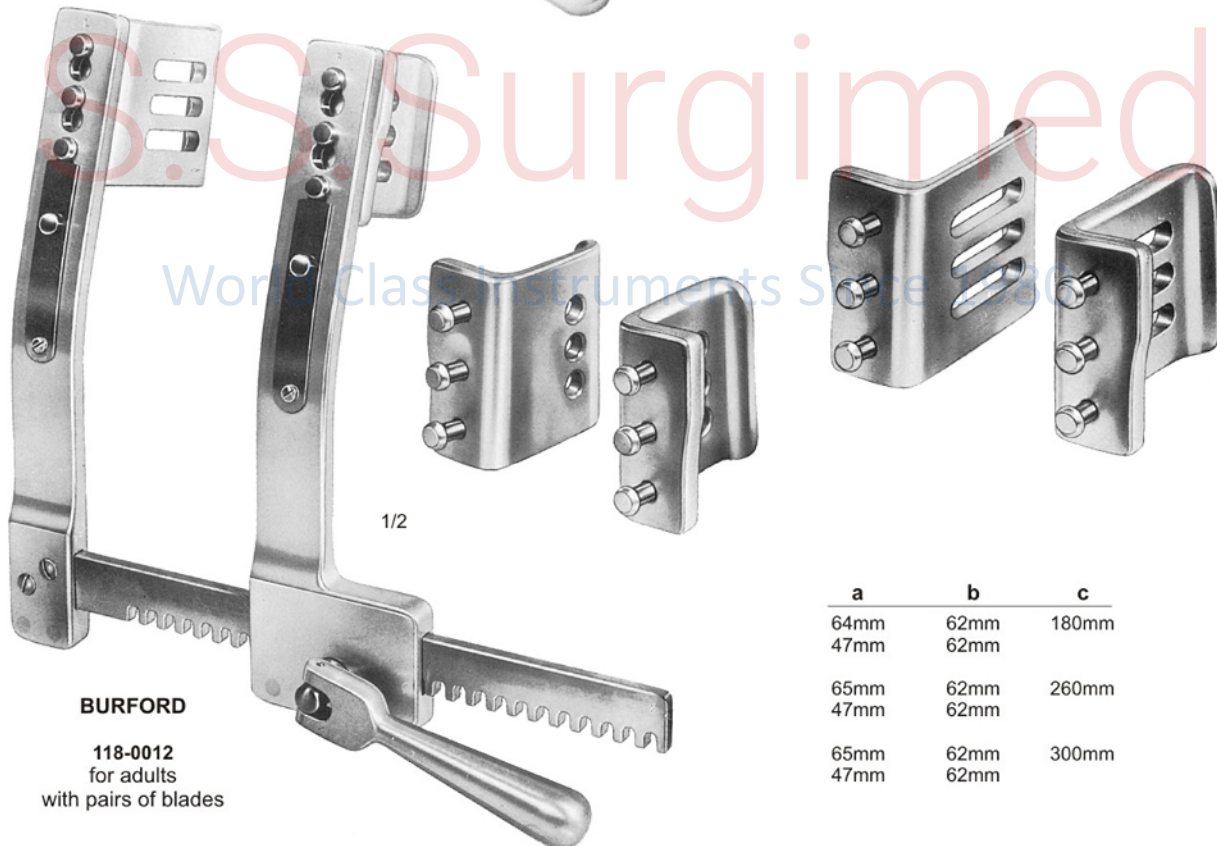

**BURFORD**  
118-0012  
for adults  
with pairs of blades



●●● Bronchus, Ligature, Tissue & Organ Holding Forceps

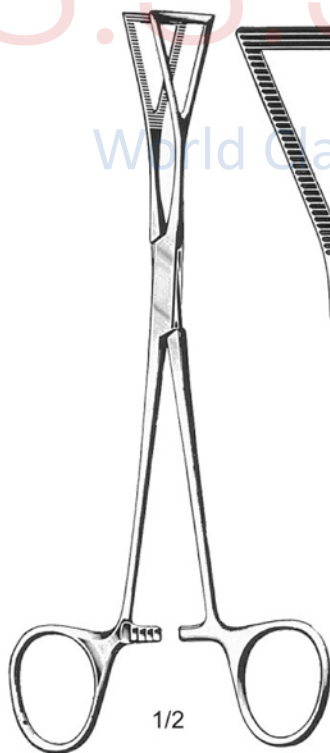
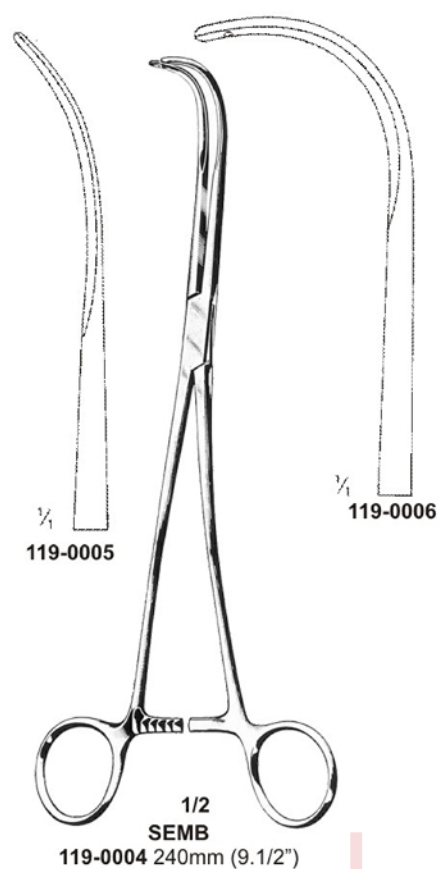
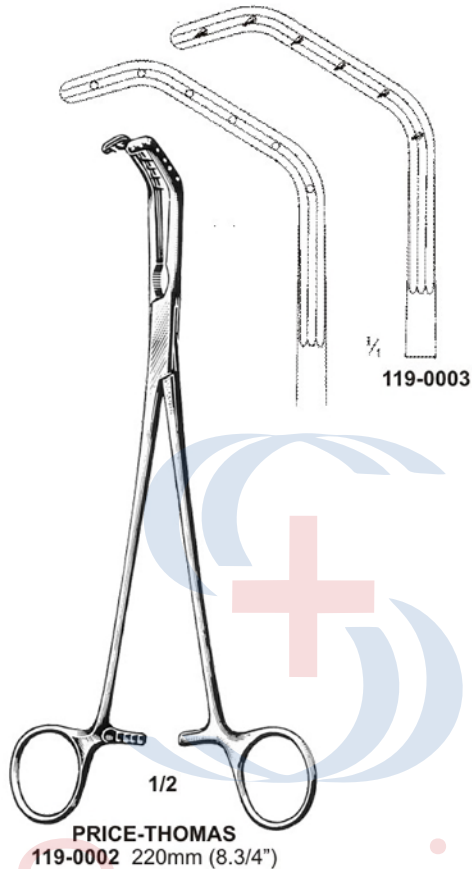
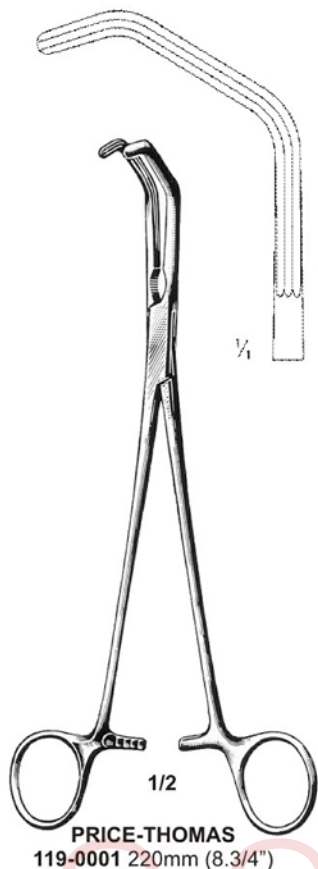

LOVELACE  
Straight  
119-0007  
200mm (8")

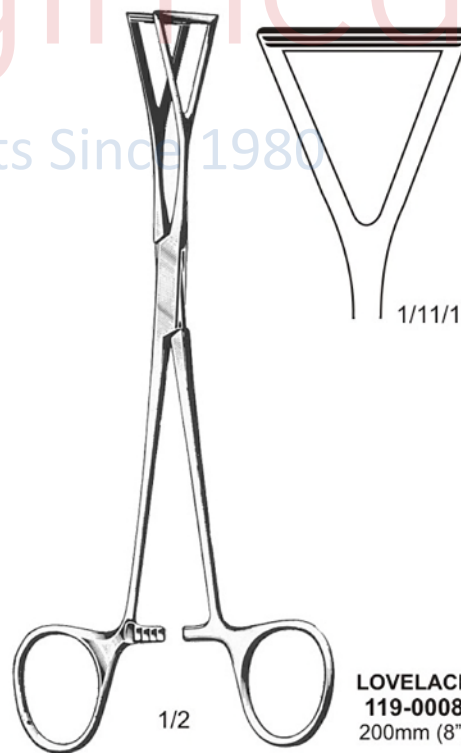

LOVELACE  
119-0008  
200mm (8")





S.S. Surgimed

World Class Instruments Since 1980

# SURGICAL INSTRUMENTS

## Atrauma Bulldog Clamps ●●●

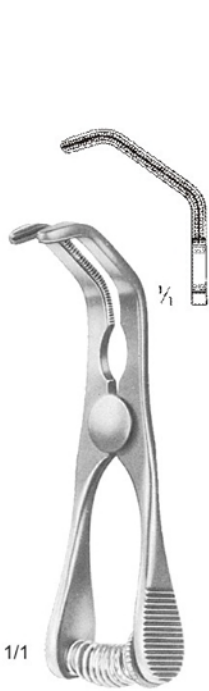

**DE-BAKEY SATINSKY**  
119-0009 70mm (2.3/4")

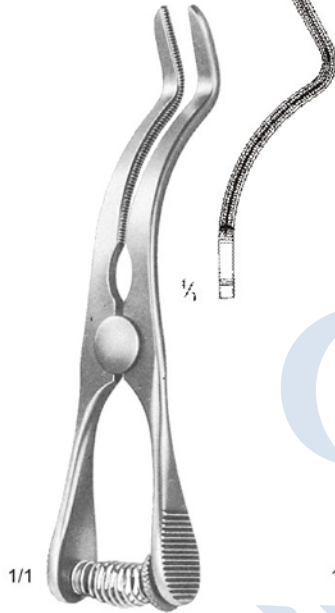

**DE BAKEY-CAROTIS**  
119-0010 90mm (3.1/2")

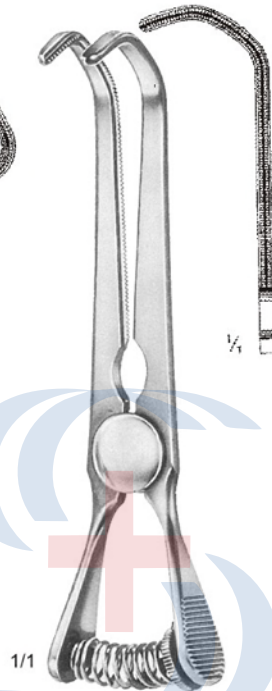

**DE BAKEY SATINSKY**  
119-0011 100mm (4")



119-0012

**GREGORY-SOFT**

119-0012  
90mm (3/12")

119-0014  
110mm (4.1/2")



119-0013



**DEBAKEY BULLDOG CLAMPS**



119-0014  
75mm (3")



119-0015  
85mm (3.1/2")



119-0016  
105mm (4.1/4")



119-0017  
120mm (4.3/4")

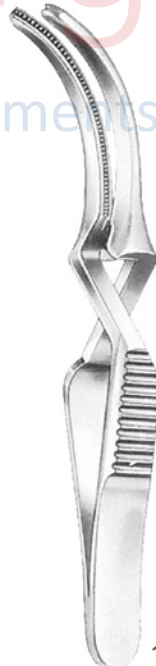

**DEBAKEY BULLDOG CLAMPS**



119-0018  
70mm (2.3/4")



119-0019  
80mm (3.1/4")



119-0020  
100mm (4")



119-0021  
115mm (4.3/4")

●●● Atrauma Hemostatic, Cardiovascular Forceps

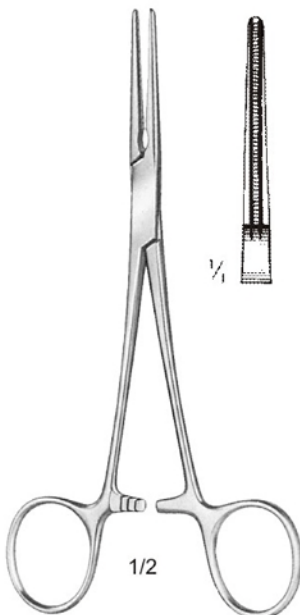

**DE BAKY-RANKIN**  
120-0001  
Straight 160mm (6.1/4")  
120-0002  
Curved 160mm (6.1/4")

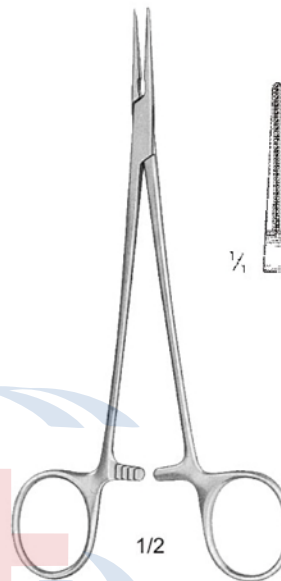

**DE BAKY-MOSQUITO**  
120-0003  
Straight 150mm (6")  
Curved 150mm (6")



**OCHSNER**  
120-0004  
235mm (9.1/4")

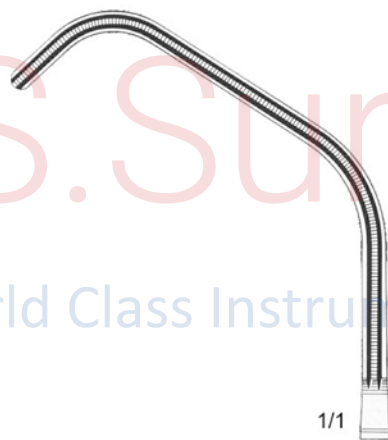

1/1



**DIETRICH**  
120-0005  
210mm (8.1/4")

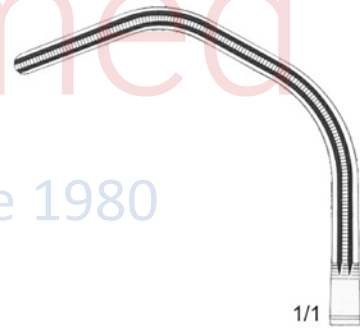

1/1



S.S. Surgimed

World Class Instruments Since 1980

# SURGICAL INSTRUMENTS

## Atrauma Cardiovascular Forceps ●●●

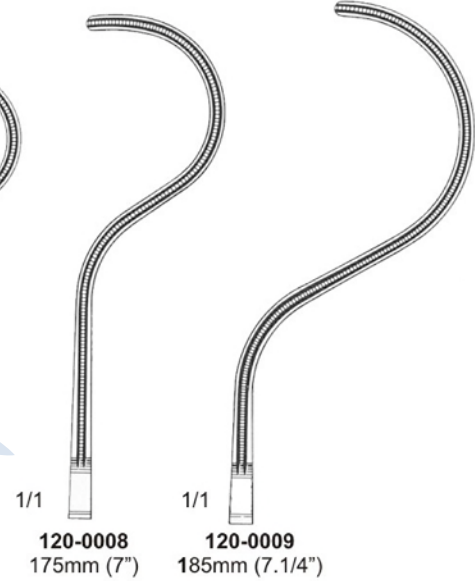
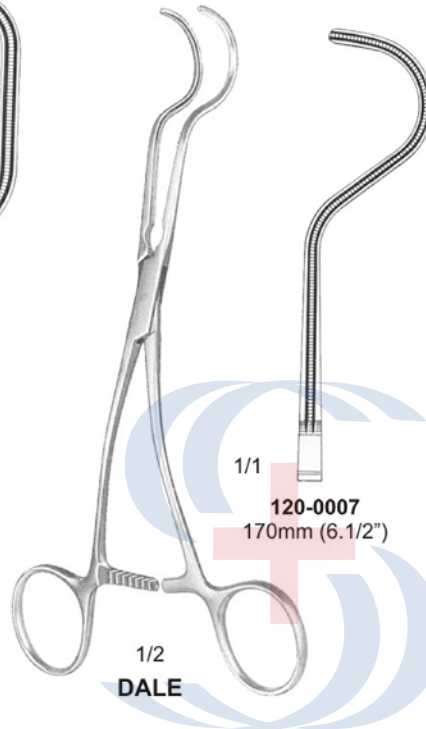
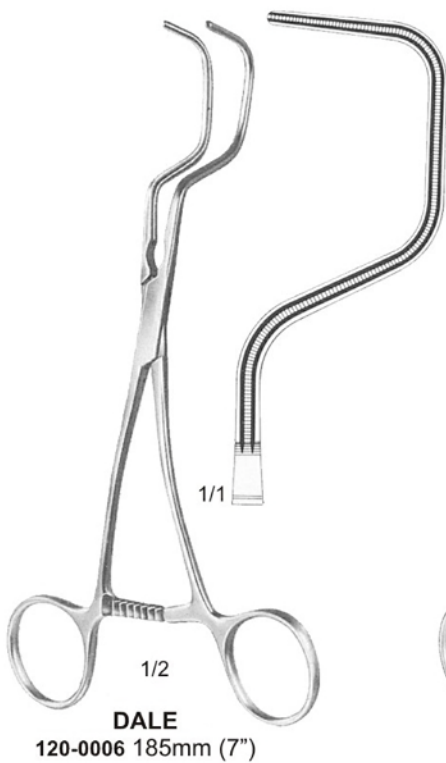

# S.S. Surgimed

World Class Instruments Since 1980

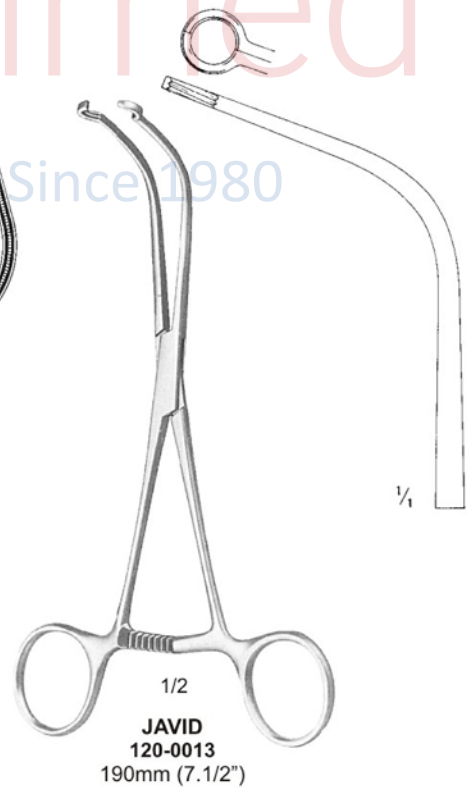
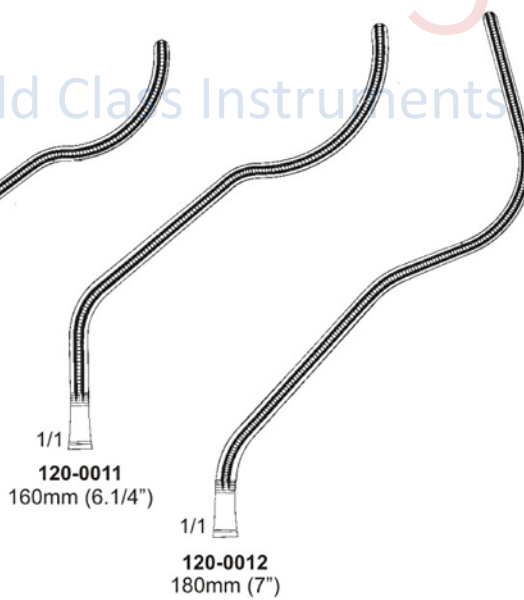
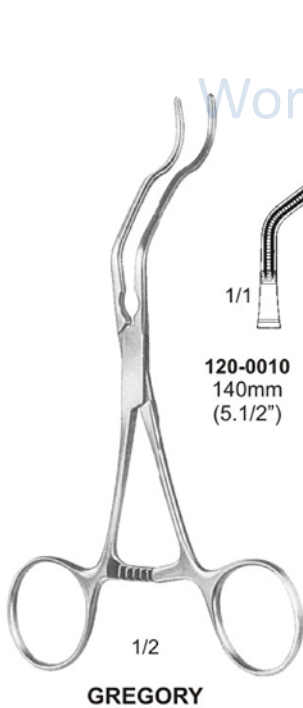



## ●●● Atrauma Cardiovascular Forceps

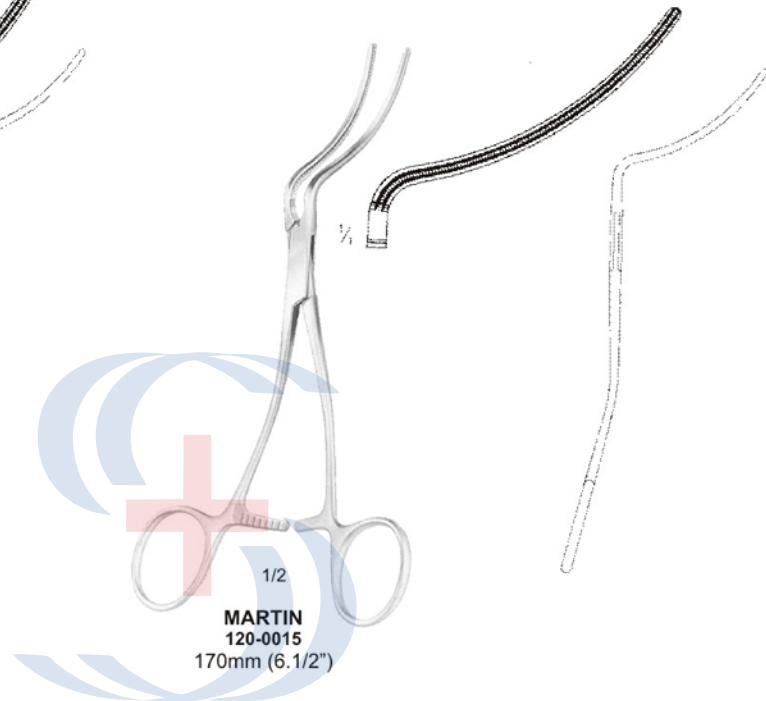
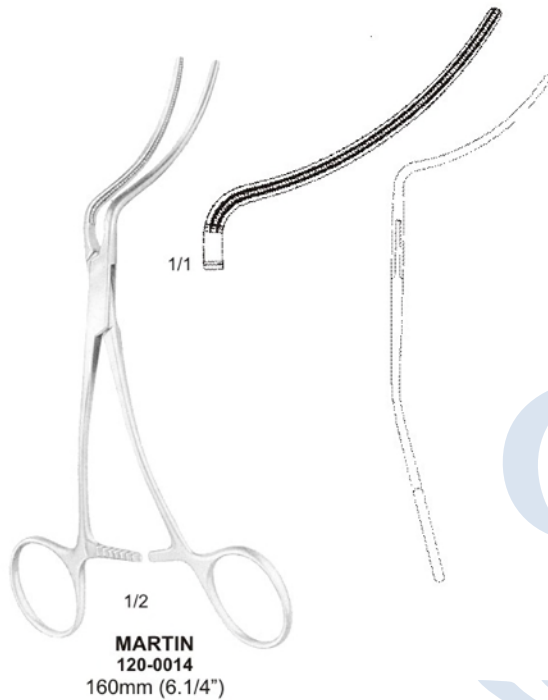

S.S. Surgimed  
World Class Instruments Since 1980

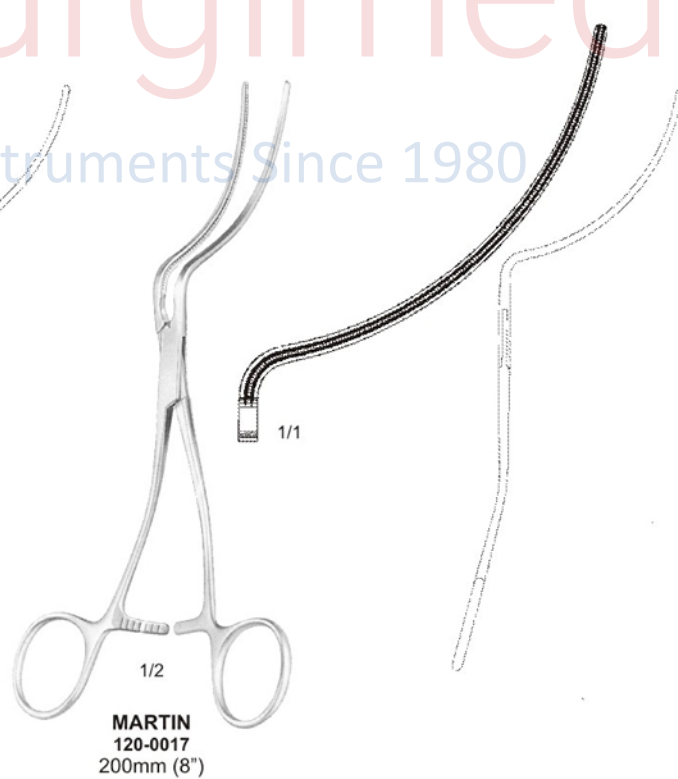
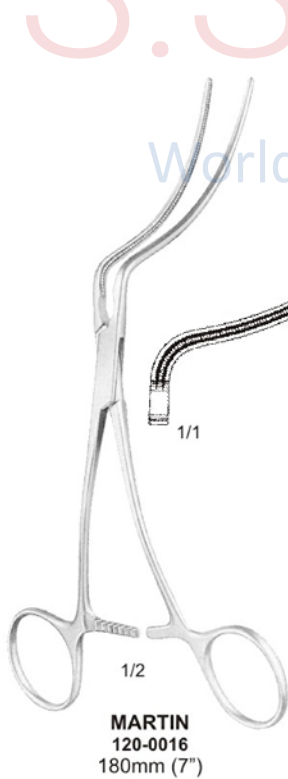



S.S. Surgimed

World Class Instruments Since 1980

# SURGICAL INSTRUMENTS

## Vascular Measuring Device, Forceps ●●●

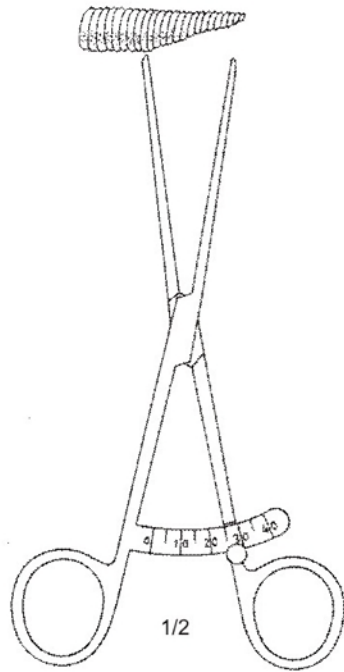

**MEASURING FORCEPS**

**120-0018**  
Straight - 180mm (7")

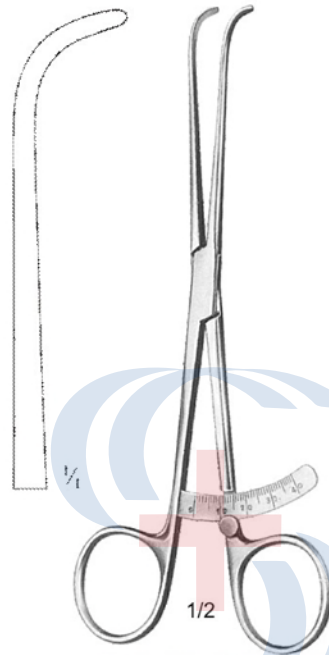

**MEASURING FORCEPS**

**120-0019**  
Straight - 180mm (7")

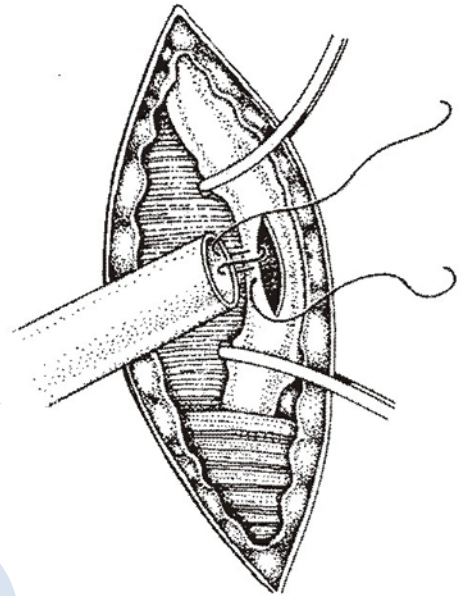

# S.S. Surgimed

World Class Instruments Since 1980

Cooley type caval occlusion used during cardiopulmonary By-Pass for occluding the vena caval. The tips of the instrument permit flow indwelling cannula

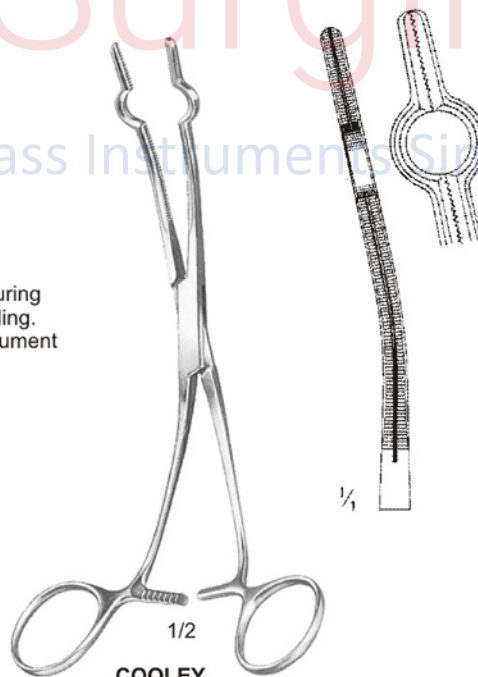

**COOLEY**  
**120-0020**  
child  
**120-0021**  
adult





## ●●● Atrauma Tissue Forceps

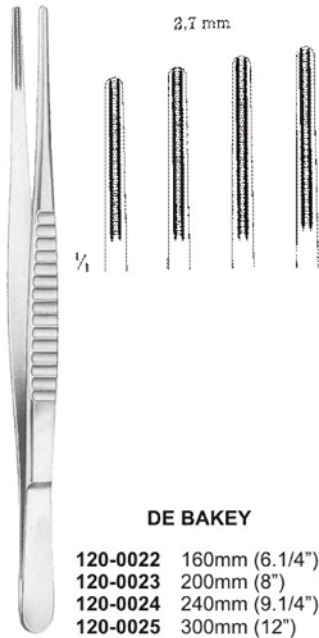

**DE BAKEY**

- 120-0022 160mm (6.1/4")
- 120-0023 200mm (8")
- 120-0024 240mm (9.1/4")
- 120-0025 300mm (12")

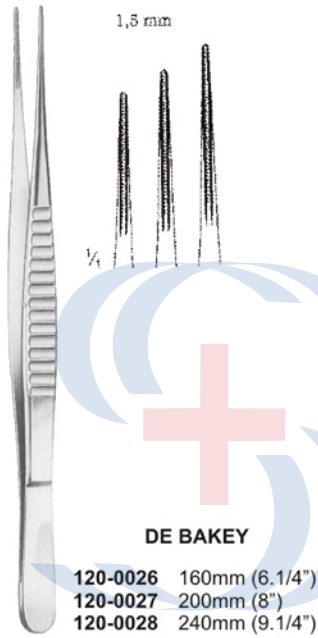

**DE BAKEY**

- 120-0026 160mm (6.1/4")
- 120-0027 200mm (8")
- 120-0028 240mm (9.1/4")

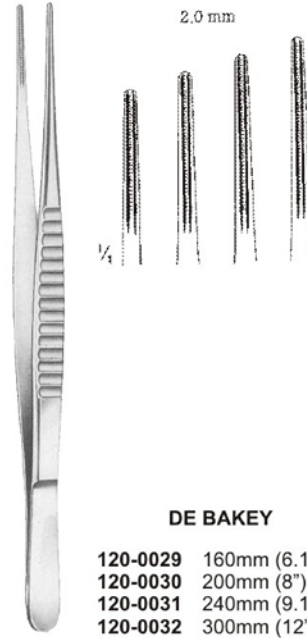

**DE BAKEY**

- 120-0029 160mm (6.1/4")
- 120-0030 200mm (8")
- 120-0031 240mm (9.1/4")
- 120-0032 300mm (12")

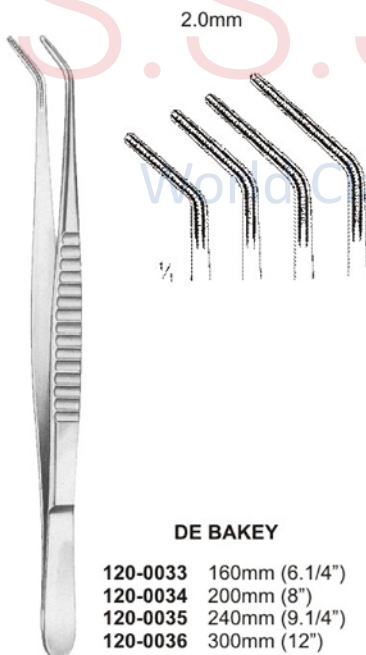

**DE BAKEY**

- 120-0033 160mm (6.1/4")
- 120-0034 200mm (8")
- 120-0035 240mm (9.1/4")
- 120-0036 300mm (12")

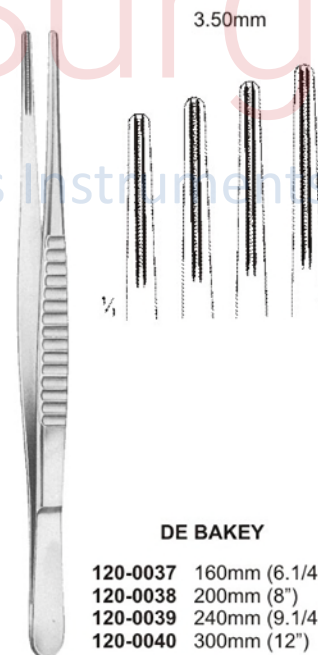

**DE BAKEY**

- 120-0037 160mm (6.1/4")
- 120-0038 200mm (8")
- 120-0039 240mm (9.1/4")
- 120-0040 300mm (12")

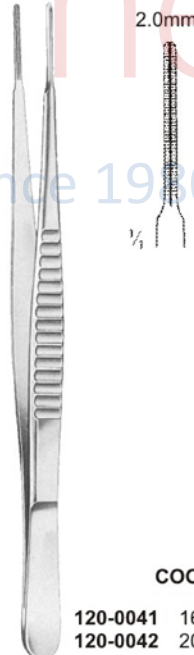

**COOLEY**

- 120-0041 160mm (6.1/4")
- 120-0042 200mm (8")



S.S. Surgimed

World Class Instruments Since 1980

# SURGICAL INSTRUMENTS

## Atrauma Cardiovascular Forceps ●●●

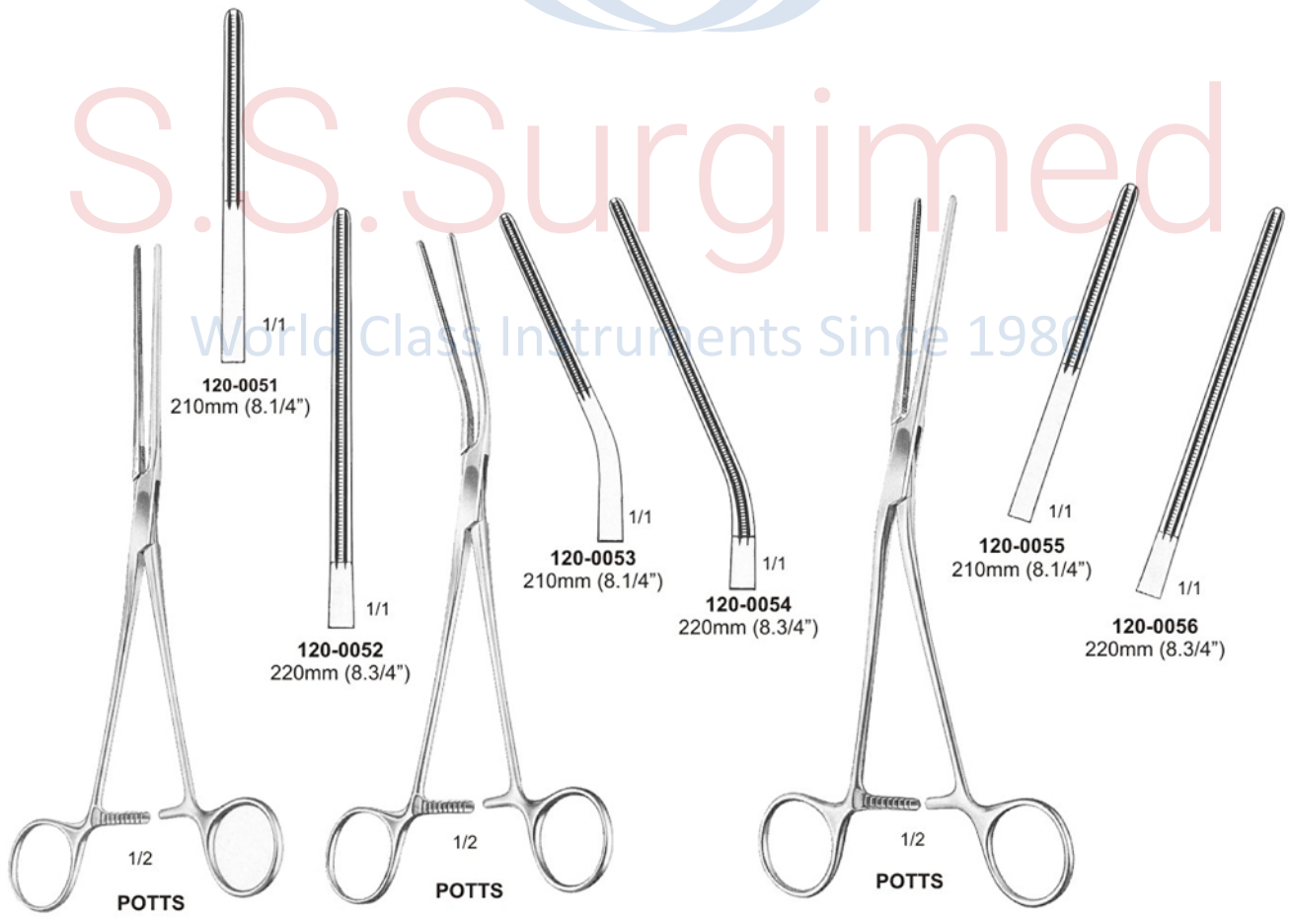
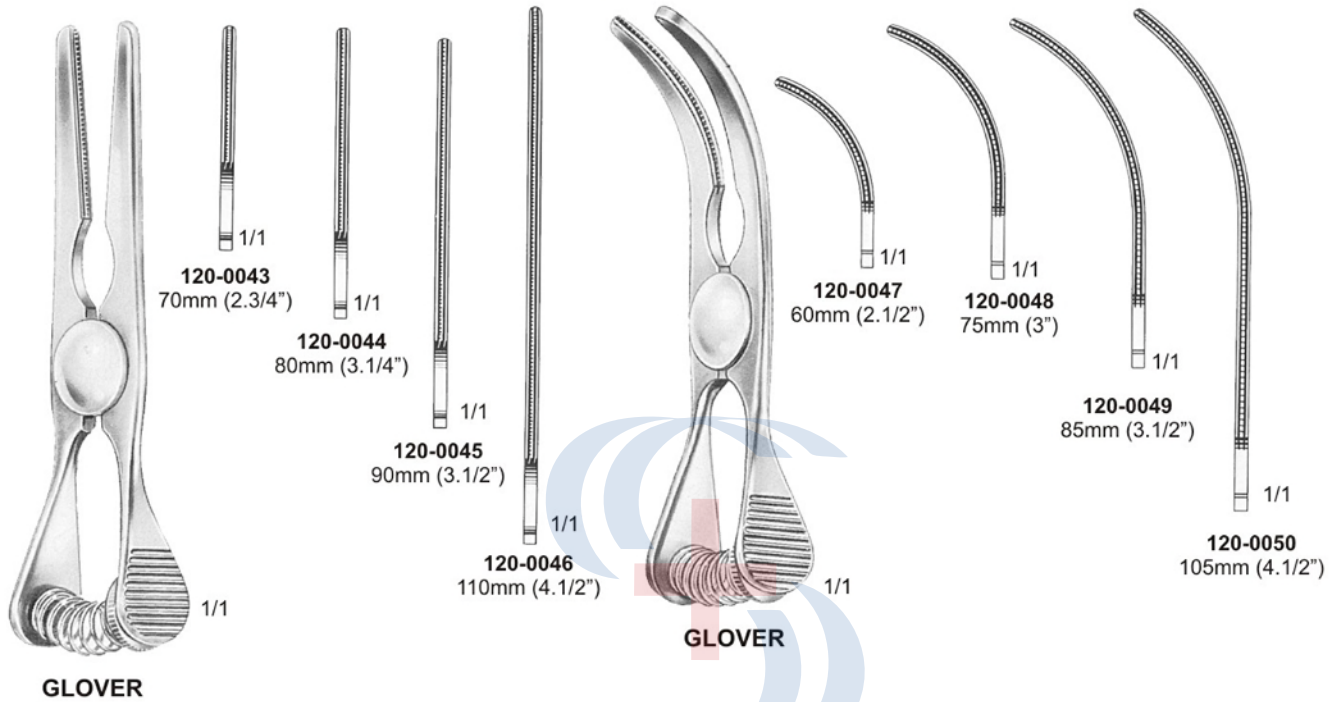



●●● Atrauma Cardiovascular Forceps

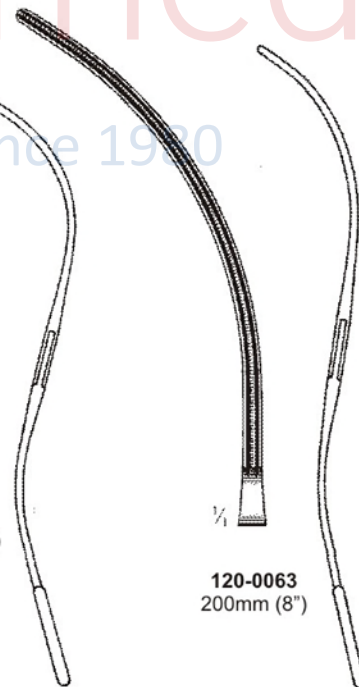
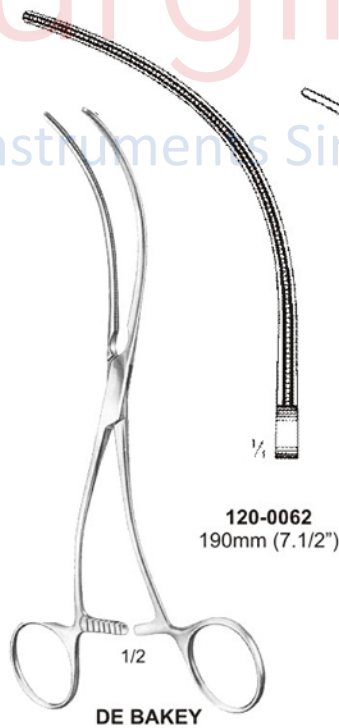
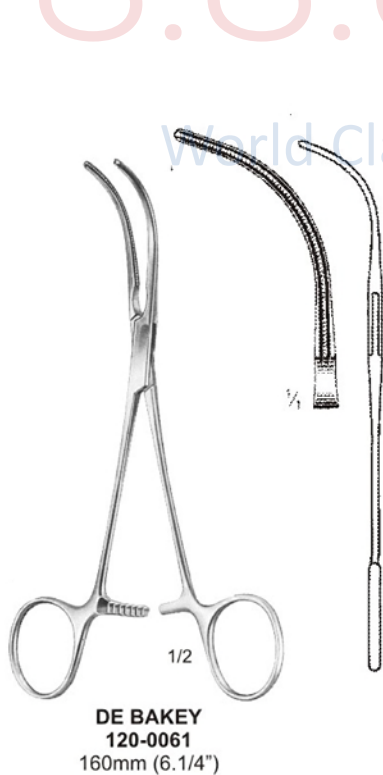
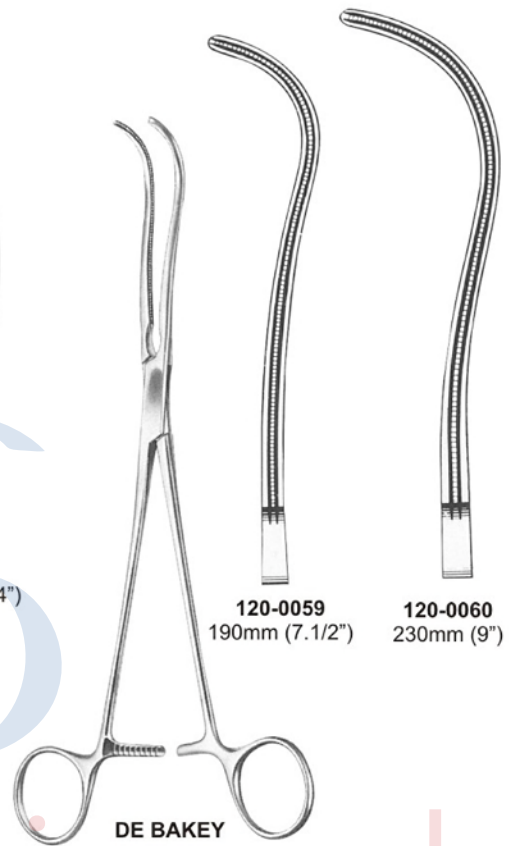
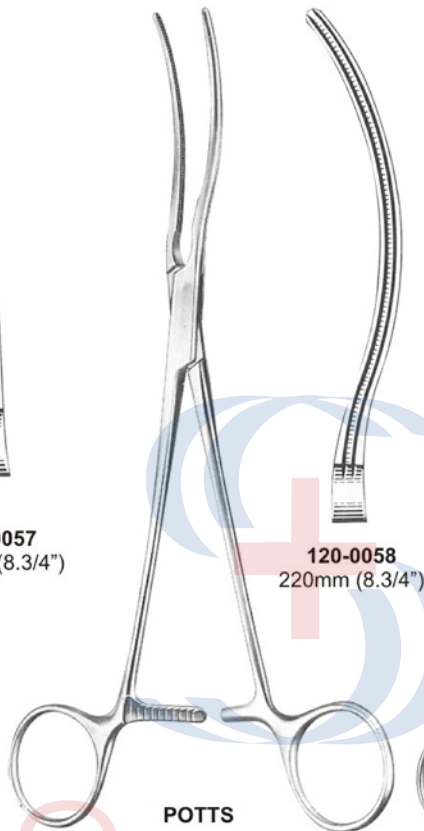



S.S. Surgimed

World Class Instruments Since 1980

# SURGICAL INSTRUMENTS

## Atrauma Cardiovascular Forceps ●●●



LELAND JONES

Fig-1  
120-0064  
180mm (7")

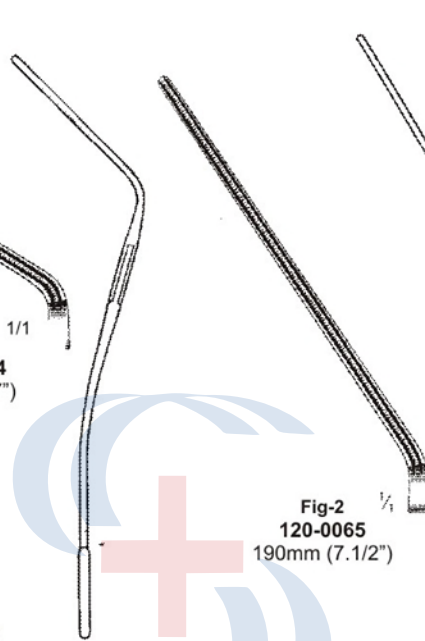

Fig-2  
120-0065  
190mm (7.1/2")

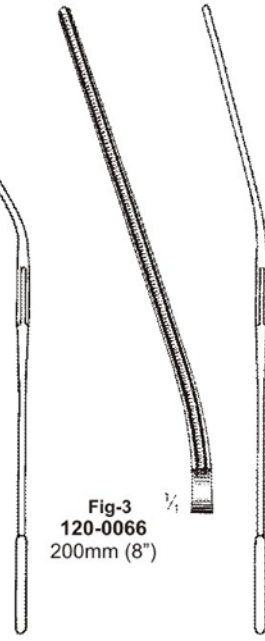

Fig-3  
120-0066  
200mm (8")



BAINBRIDGE

120-0067  
150mm (6")

120-0068  
180mm (7")

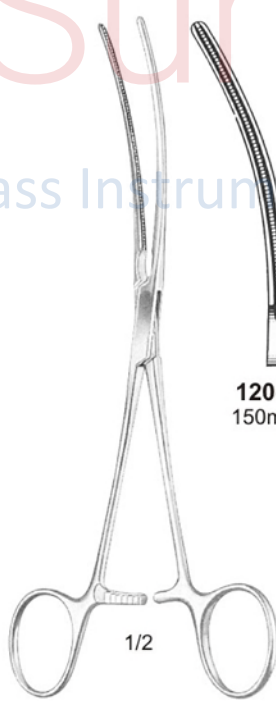

BAINBRIDGE

120-0069  
150mm (6")

120-0070  
180mm (7")

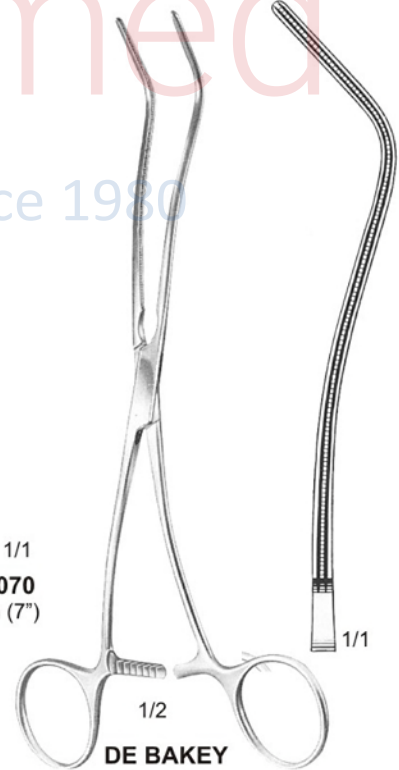

DE BAKEY  
120-0071  
200mm (8")

## ●●● Atrauma Cardiovascular Forceps

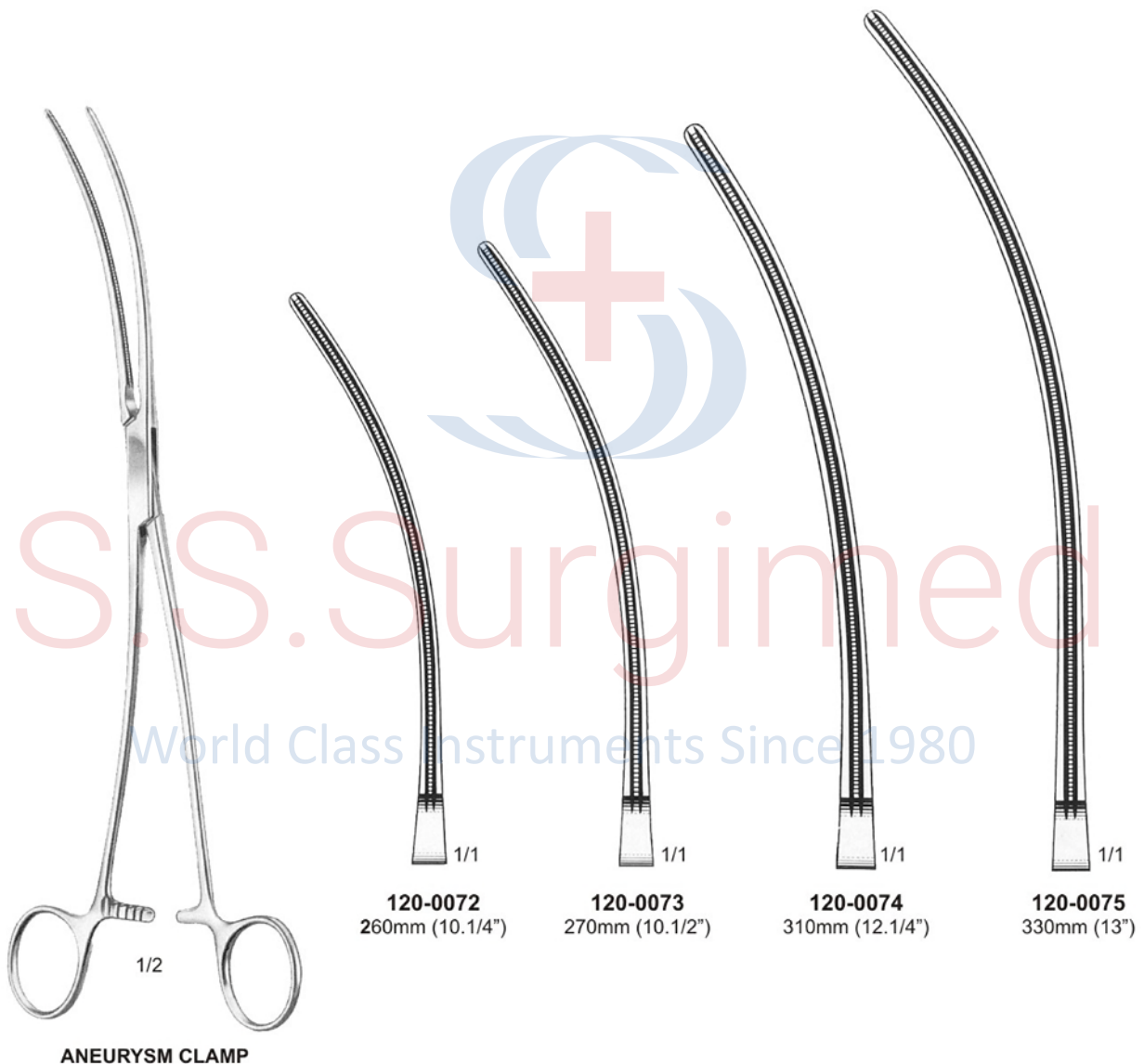





S.S. Surgimed

World Class Instruments Since 1980

# SURGICAL INSTRUMENTS

## Atrauma Cardiovascular Forceps ●●●

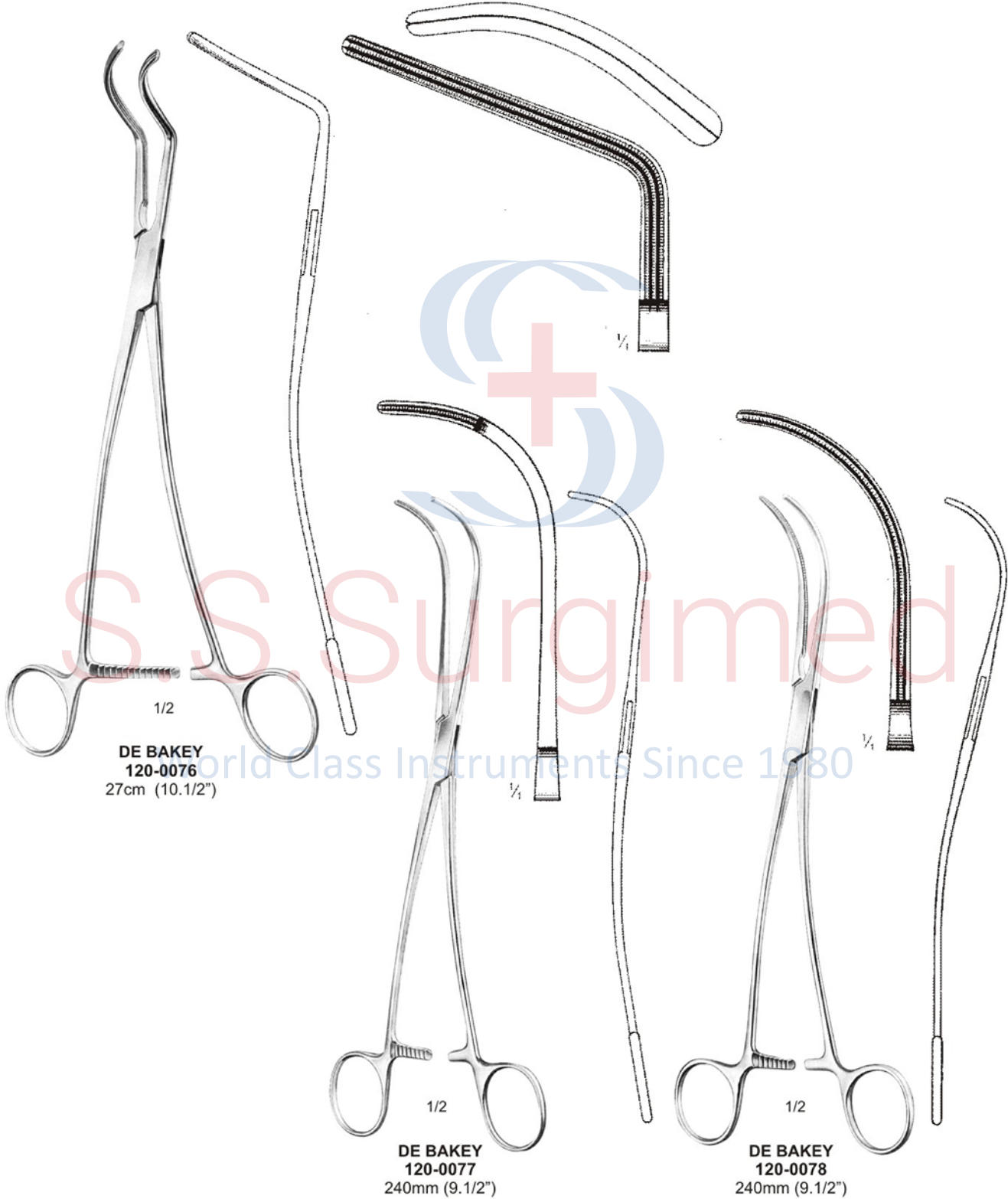

1/2  
**DE BAKAY**  
**120-0076**  
 27cm (10.1/2")

1/2  
**DE BAKAY**  
**120-0077**  
 240mm (9.1/2")

1/2  
**DE BAKAY**  
**120-0078**  
 240mm (9.1/2")

## ●●● Atrauma Cardiovascular Forceps

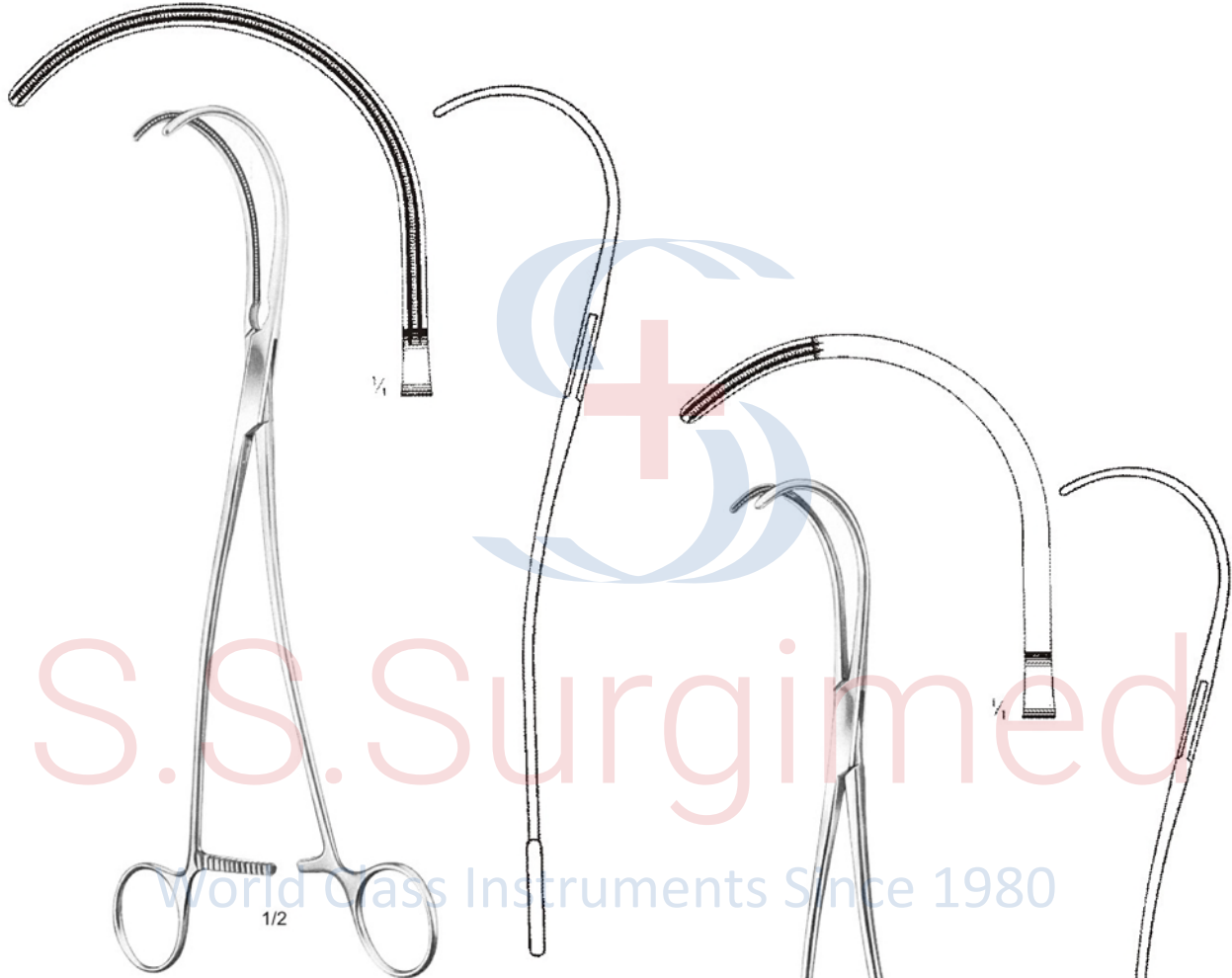

**DE BAKEY**  
120-0079  
260mm (10")

1/2  
**DE BEKAY**  
120-0080  
250mm (10")



S.S. Surgimed

World Class Instruments Since 1980

# SURGICAL INSTRUMENTS

## Atrauma Cardiovascular Forceps ●●●



1/2  
**LAMBERT - KAY**

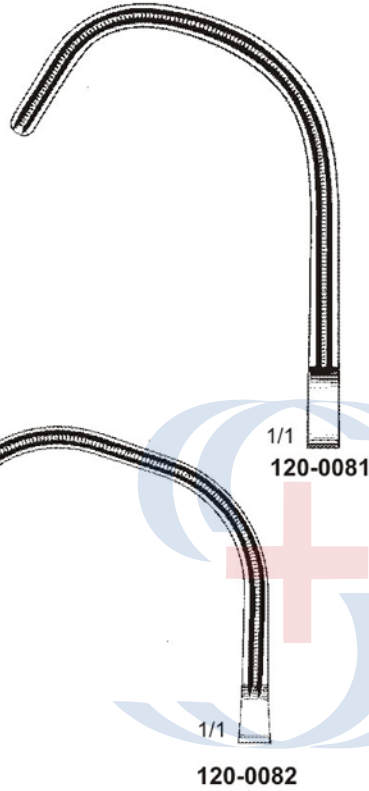

1/1  
**120-0081**

1/1  
**120-0082**



1/2  
**DE BAKEY**  
**120-0083**  
170mm (6.3/4")

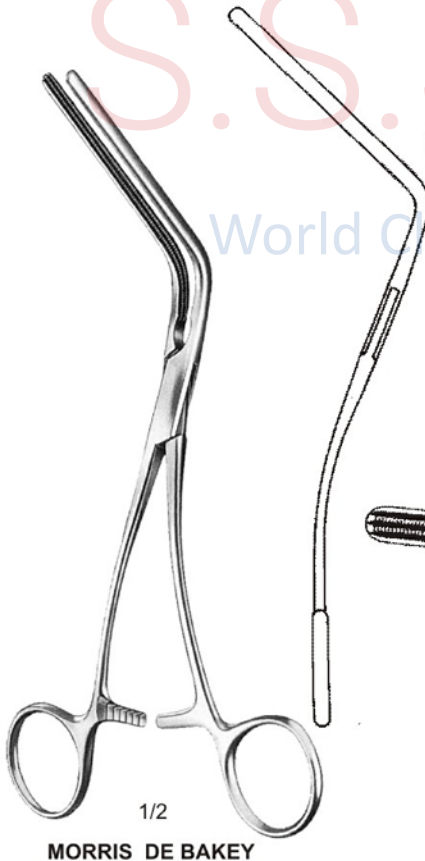

1/2  
**MORRIS DE BAKEY**

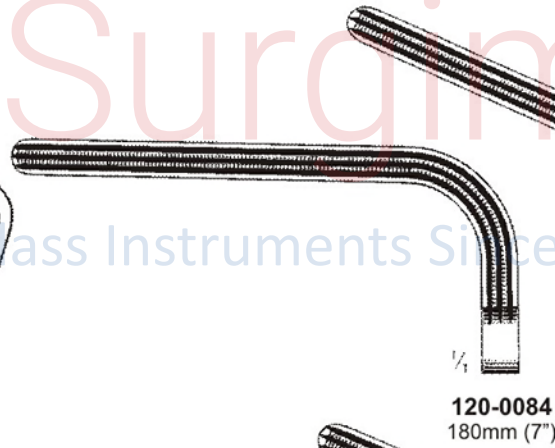

1/4  
**120-0084**  
180mm (7")

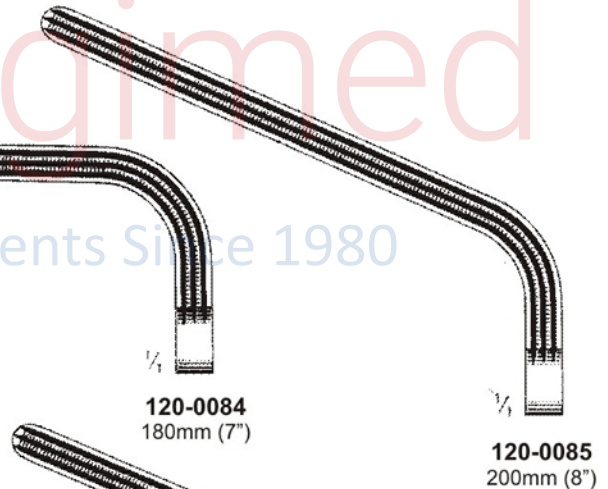

1/4  
**120-0085**  
200mm (8")

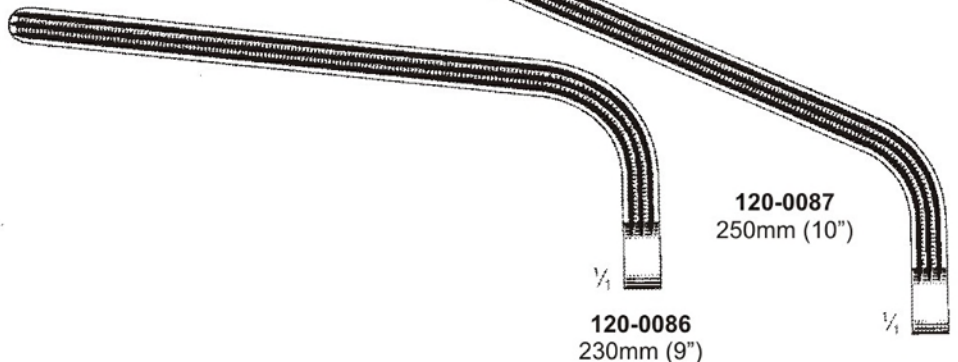

1/4  
**120-0086**  
230mm (9")

1/4  
**120-0087**  
250mm (10")

●●● Atrauma Cardiovascular Forceps



**120-0088**  
215mm (8.1/2")



**120-0089**  
230mm (9")



**120-0090**  
270mm (10.1/2")



**120-0091**  
315mm (12.1/2")



**120-0092**  
215mm (8.1/2")



**120-0093**  
230mm (9")



**120-0094**  
270mm (10.1/2")



**120-0095**  
315mm (12.1/2")



S.S. Surgimed

World Class Instruments Since 1980

# SURGICAL INSTRUMENTS

## Atrauma Cardiovascular Forceps ●●●

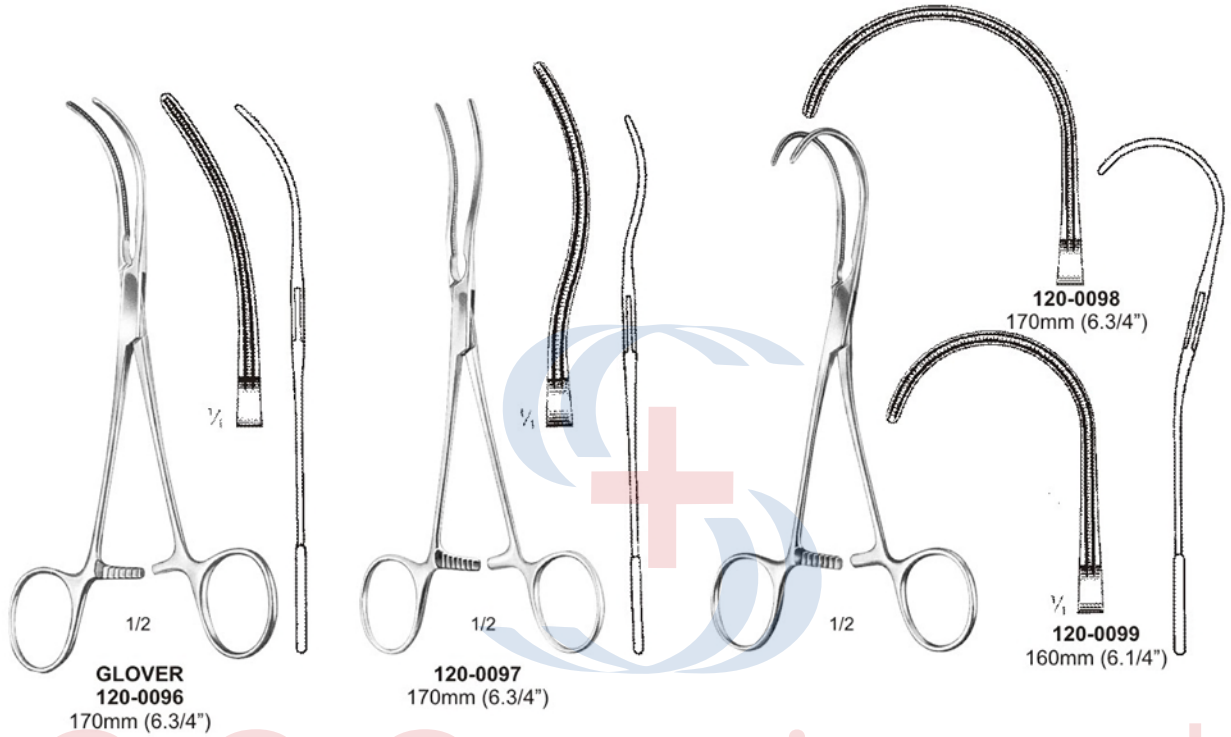

S.S. Surgimed  
World Class Instruments Since 1980

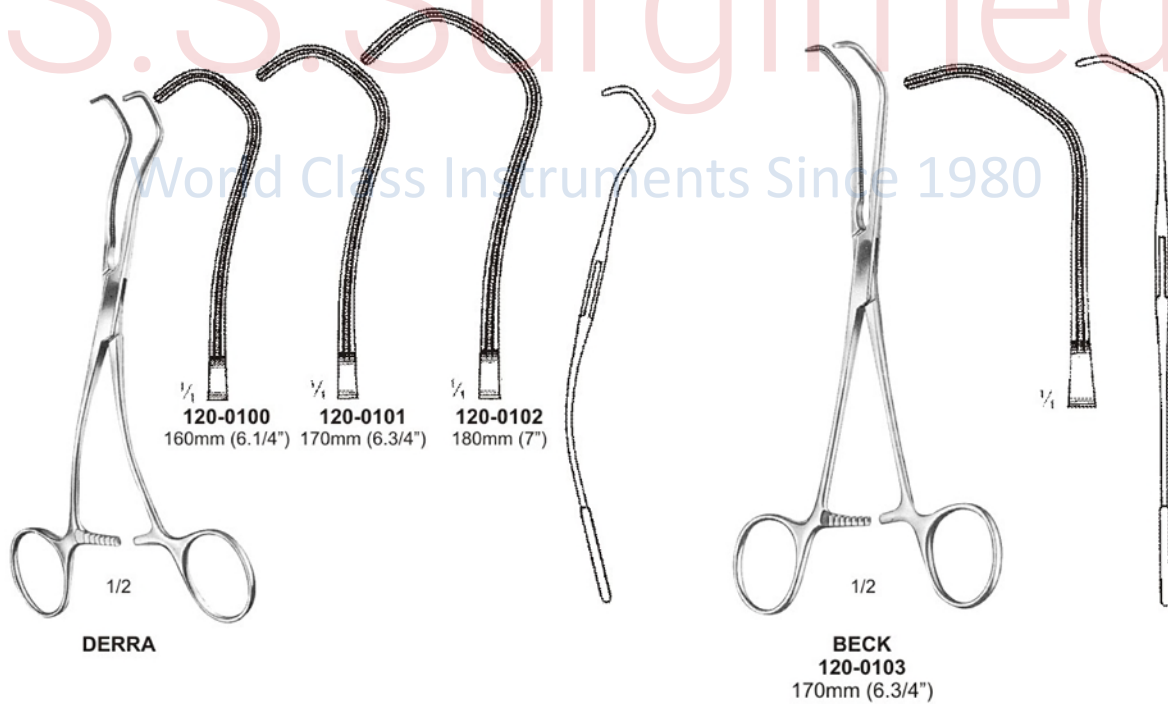



## ●●● Vascular Dilators

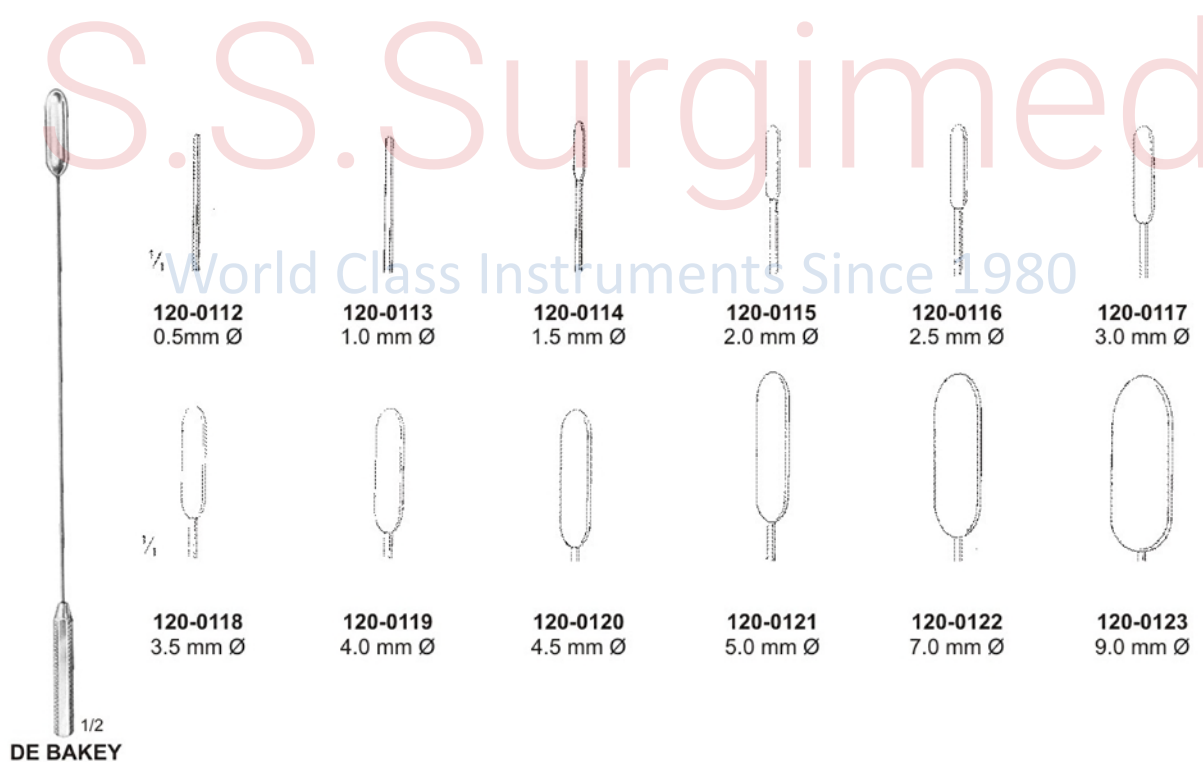
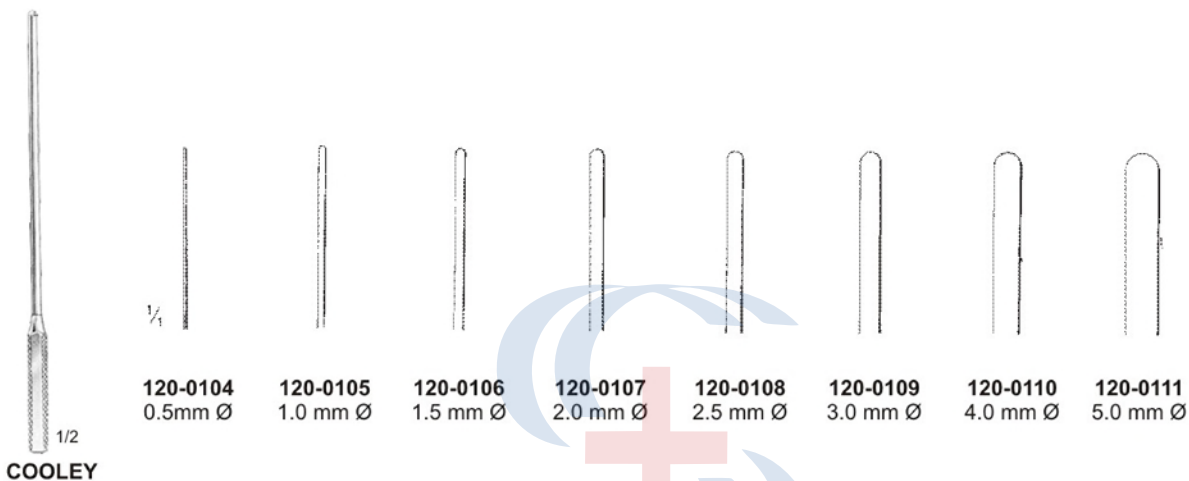



S.S.Surgimed

World Class Instruments Since 1980

# SURGICAL INSTRUMENTS

## Bipolar Forceps ●●●



**McPHERSON**  
**121-0001**  
70mm  
(2.3/4")  
Straight

**McPHERSON**  
**121-0002**  
70mm  
(2.3/4")  
Angled

**JEWELER FORCEPS**  
**121-0003**  
110 mm  
(4.1/4")  
Straight

**JEWELER FORCEPS**  
**121-0004**  
110 mm  
(4.1/4")  
Angled

**JEWELER FORCEPS**  
**121-0005**  
110 mm  
(4.1/4")  
Curved

**BIPOLAR FORCEPS**  
Straight  
**121-0006** 150mm (6")  
**121-0007** 180mm (7")  
**121-0008** 200mm (8")  
**121-0009** 220mm (8.1/2")  
**121-0010** 240mm (9.1/2")

●●● Bipolar Forceps

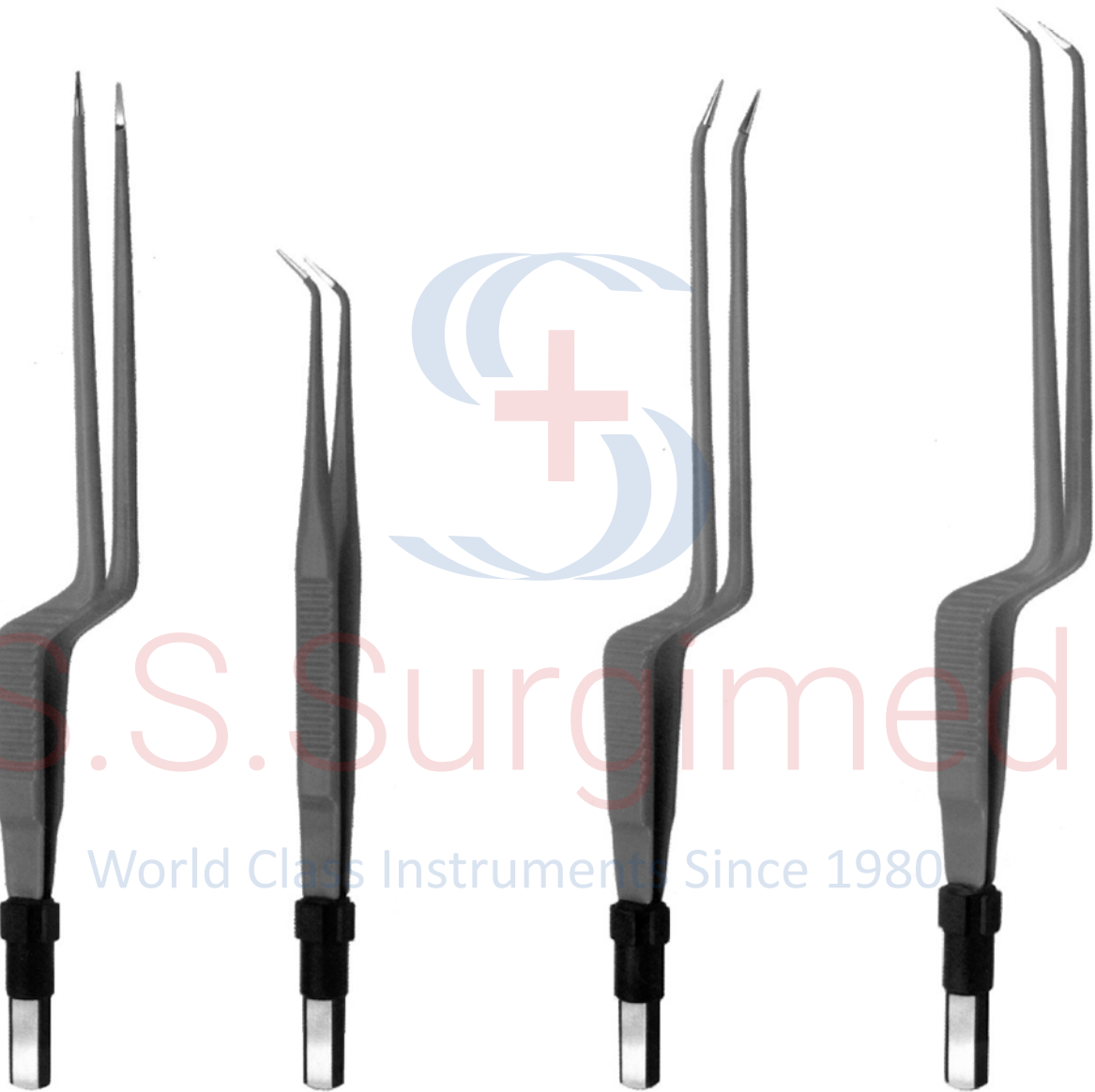

**BIPOLAR FORCEPS  
BAYONETT**

- 121-0011** 180mm (7")
- 121-0012** 200mm (8")
- 121-0013** 220mm (8.1/2")
- 121-0014** 240mm (9.1/2")

**BIPOLAR FORCEPS  
Angled downward**

- 121-0015** 150mm (6")
- 121-0016** 180mm (7")
- 121-0017** 200mm (8")
- 121-0018** 220mm (8.1/2")
- 121-0019** 240mm (9.1/2")

**BIPOLAR FORCEPS  
BAYONETT**

- Angled Upward**
- 121-0020** 180mm (7")
- 121-0021** 200mm (8")
- 121-0022** 220mm (8.1/2")
- 121-0023** 240mm (9.1/2")

**BIPOLAR FORCEPS  
BAYONETT**

- Angled Downward**
- 121-0024** 180mm (7")
- 121-0025** 200mm (8")
- 121-0026** 220mm (8.1/2")
- 121-0027** 240mm (9.1/2")



## Monopolar Cables, Forceps ●●●

### MONOPOLAR CABLES

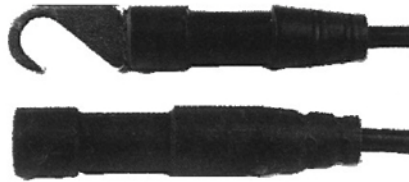

- 121-0028** 3 meter cable, Hook connector, cable with active instrument connector
- 121-0029** 5 meter cable, Hook connector, cable with active instrument connector

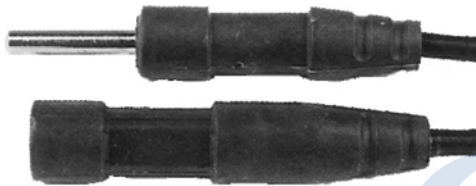

- 121-0030** 3 meter cable, 4mm plug, cable with active instrument connector
- 121-0031** 5 meter cable, 4mm plug, cable with active instrument connector

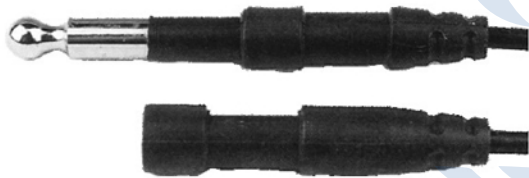

- 121-0032** 3 meter cable, 8mm jack plug (Bovie) cable with active instrument connector
- 121-0033** 5 meter cable, 8mm jack plug (Bovie) cable with active instrument connector



**DISSECTING FORCEPS**  
**121-0034**  
 150mm (6")  
 180mm (7")



**DISSECTING FORCEPS**  
**121-0035**  
 200mm (8")  
 250mm (10")



**MCINDOE FORCEPS**  
**121-0036**  
 150mm (6")



**ADSON**  
**121-0037**  
 100mm (7.1/2")



**WILSON HEY FORCEPS**  
**121-0038**  
 150mm (6")



**WILSON HEY FORCEPS**  
**121-0039** 180mm (7"),  
**121-0040** 230mm (9")

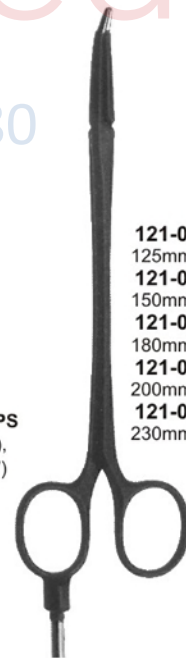

**RICHES FORCEPS**

- 121-0041** 125mm (5")
- 121-0042** 150mm (6")
- 121-0043** 180mm (7")
- 121-0044** 200mm (8")
- 121-0045** 230mm (9")



●●● Monopolar Handles, Blades, Needle, Turner W



**HANDLES**  
For ball and  
plate electrode carriers

**121-0046**  
17mm (6.1/4")



**HANDLES**  
For needles and loops

**121-0047**  
200mm (8")



**HANDLES**  
For needles and loops

**121-0048**  
15mm (6")



**BLADES**

**121-0049**  
Large Diathermy  
blade electrode  
(Insulated)



**BLADES**

**121-0050**  
Large Diathermy  
blade electrode  
(Non-Insulated)



**BLADES**

**121-0051**  
Small  
Diathermy  
blade electrode



**NEEDLE**

**121-0052**  
Short Sharp



**NEEDLE**

**121-0053**  
Long Insulated



**NEEDLE**

**121-0054**  
Long Sharp  
Angled



**NEEDLE**

**121-0055**  
Long Sharp  
Straight



**TURNER WARWICK  
SCISSOR**

**121-0056** 125mm (5")  
**121-0057** 145mm (5.1/4")  
**121-0058** 150mm (6")  
**121-0059** 180mm (7")  
**121-0060** 230mm (9")



**SCALPLE HANDLE**

**121-0061**  
No3, No4





S.S.Surgimed

World Class Instruments Since 1980

# SURGICAL INSTRUMENTS

## Dissection Instruments ●●●

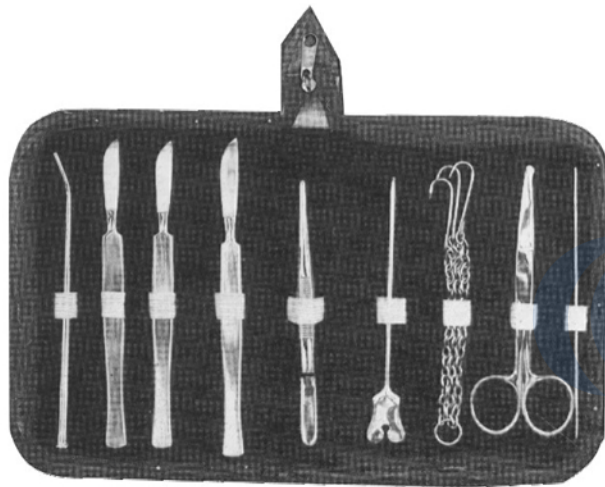

### 122-0001

- 1- BLOW PIPE
- 2- 3 PCS. SCALPEL
- 3- DISSECTING FORCEP 13 CM.
- 4- GROOVED DIRECTOR WITH TONGUE TIE 13 CM
- 5- TRIPLE CHAIN HOOK
- 6- DRESSING SCISSORS PROBE POINTED 13 CM
- 7- PROBE DOUBLE 13 CM
- 8- ZIPPER CASE INSIDE RED VELVET.

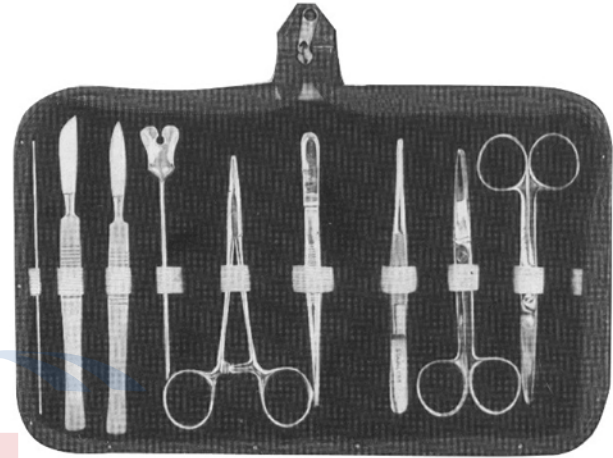

### 122-0002

- 1- PROBE DOUBLE 13 CM
- 2- 2 PCS. SCALPEL S.S.
- 3- GROOVED DIRECTOR WITH TONGUE TIE 13 CM
- 4- MAYO HEGAR NEEDLE HOLDER 13CM
- 5- DISSECTING FORCEP 13 CM 1x2 TEETH
- 6- DRESSING FORCEP 13 CMS SERRATED.
- 7- DRESSING SCISSOR 13 CM S/B STR.
- 8- DRESSING SCISSOR 13 CM S/B CVD.
- 9- ZIPPER CASE INSIDE RED VELVET.



### 122-0003

- 1- DISSECTING FORCEP 11.5 CM SHARP POINT.
- 2- TEASING NEEDLE SHARP STR.
- 3- B.P HANDLE NO. 4
- 4- TEASING NEEDLE SHARP ANGULAR
- 5- BLADE NO. 22
- 6- THUMB FORCEP T.O.E. 13 CM
- 7- DISSECTING SCISSOR STR 11.5 CM
- 8- DISSECTING SCISSOR STR 13 CM
- 9- ZIPPER CASE INSIDE RED VELVET.



### 122-0004

- 1- GROOVED DIRECTOR WITH TONGUE TIE 14 CM
- 2- PROBE DOUBLE 14CM
- 3- MAYO HEGAR NEEDLE HOLDER 14 CM
- 4- BP. HANDLE NO.3
- 5- BP. HANDLE NO.4
- 6- DRESSING SCISSOR 14 CM S/B STR
- 7- DRESSING SCISSOR 14 CM S/B CVD.
- 8- DRESSING FORCEP 1x2 TEETH 14 CM
- 9- DRESSING FORCEP SERRATED 14 CM

## ●●● Dissection Instruments

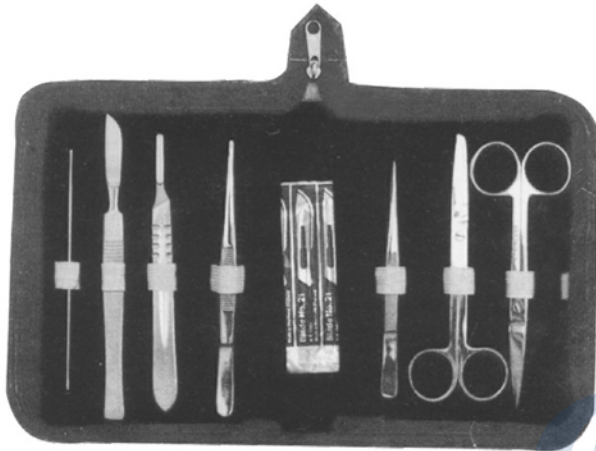

### 122-0005

- 1- PROBE DOUBLE 12.5 CM
- 2- SCALPEL.
- 3- B.P. HANDLE NO. 4
- 4- 6 PCS BLADE 2 EACH NO. 21, 22, 23
- 5- DISSECTING FORCEP 12.5 CM
- 6- DISSECTING FORCEP 11.5 CM SHARP POINT.
- 7- DRESSING SCISSOR S/B STR. 13 CM
- 8- DRESSING SCISSOR S/S STR. 13 CM

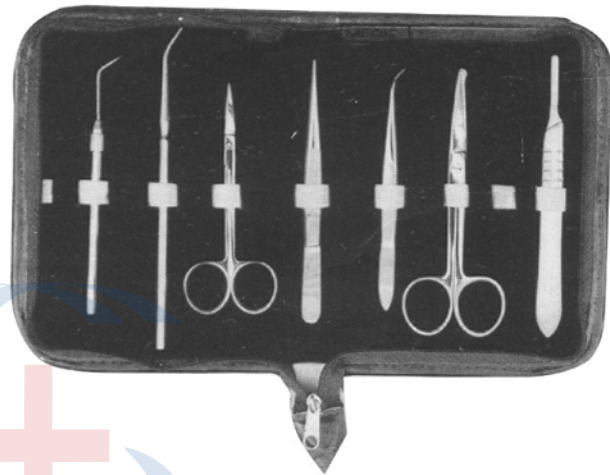

### 122-0006

- 1- TEASING NEEDLE WITH CHUCK CVD.
- 2- HUBER PROBE
- 3- IRIS SCISSOR
- 4- DISSECTING FORCEP FINE 14 CM.
- 5- DISSECTING FORCEP FINE CVD. 12 CM
- 6- OPERATING SCISSOR WITH PROBE 14 CM.
- 7- B.P. HANDLE NO. 4

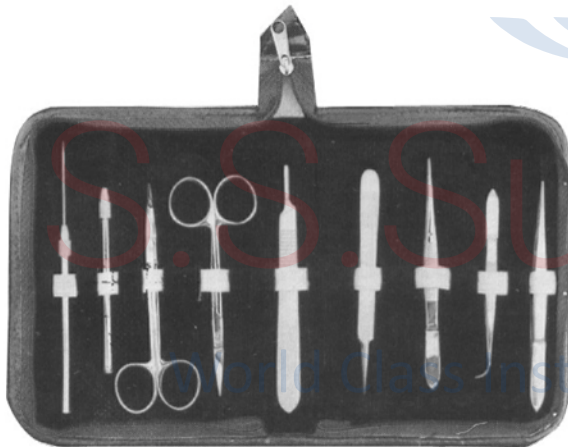

### 122-0007

- 1- DISSECTING FORCEP FINE 14 CM.
- 2- DISSECTING FORCEP FINE CVD 12 CM.
- 3- DISSECTING FORCEP WITH PIN 14 CM.
- 4- WATCHMAKER FINE POINT
- 5- IRIS SCISSOR STR
- 6- IRIS SCISSOR CVD.
- 7- TEASING NEEDLE HOLDER
- 8- TEASING NEEDLE STR.
- 9- B.P. HANDLE NO. 3



### 122-0008

- 1- TEASING NEEDLE STR.
- 2- GROOVED DIRECTOR AND TONGUE TIE.
- 3- TEASING NEEDLE CVD.
- 4- DISSECTING FORCEP WITH PIN 12 CM FINE
- 5- OPERATING SCISSOR S/B STR 14 CM
- 6- TRIPLE CHAIN HOOK
- 7- PROBE WITH EYE
- 8- PROBE DOUBLE END
- 9- PROBE AND HOOK
- 10- DISSECTING FORCEP FINE 14 CM
- 11- IRIS SCISSOR
- 12- HUBER PROBE
- 13- B.P. HANDLE NO. 3
- 14- B.P. HANDLE NO. 4





S.S. Surgimed

World Class Instruments Since 1980

# SURGICAL INSTRUMENTS

## Dissection Instruments ●●●



### 122-0009

- 1- PROBE WITH EYE
- 2- DISSECTING FORCEP CVD FINE 12 CM.
- 3- IRIS SCISSOR
- 4- OPERATING CCISSOR S/B STR 14 CM
- 5- GROOVED DIRECTOR AND TONGUE TIE
- 6- HUBER PROBE
- 7- TRIPLE CHAIN HOOK
- 8- B.P. HANDLE NO. 4
- 9- B.P. HANDLE NO. 3
- 10- TEASING NEEDLE WITH CHUCK CVD.
- 11- TEASING NEEDLE WITH CHUCK STR.
- 12- DISSECTING FORCEPS FINE 14 CM

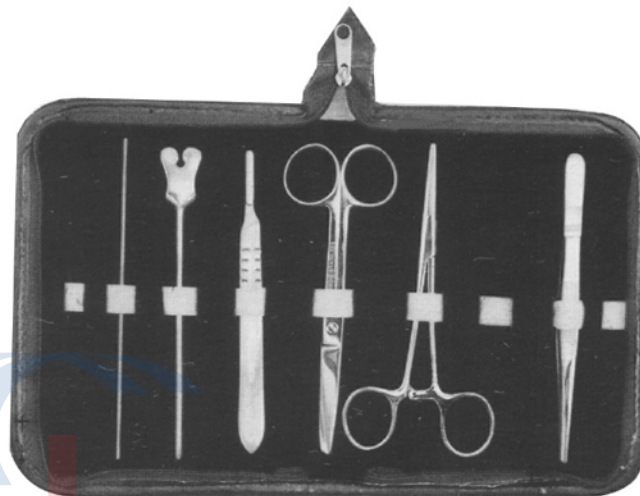

### 122-0010

- 1- PROBE DOUBLE END
- 2- GROOVED DIRECTOR AND TONGUE TIE
- 3- B.P. HANDLE NO. 4
- 4- OPERATING SCISSOR STR S/B 14 CM.
- 5- KELLY FORCEPS STR 14 CM.
- 6- DISSECTING FORCEPS THUMB 13 CM.

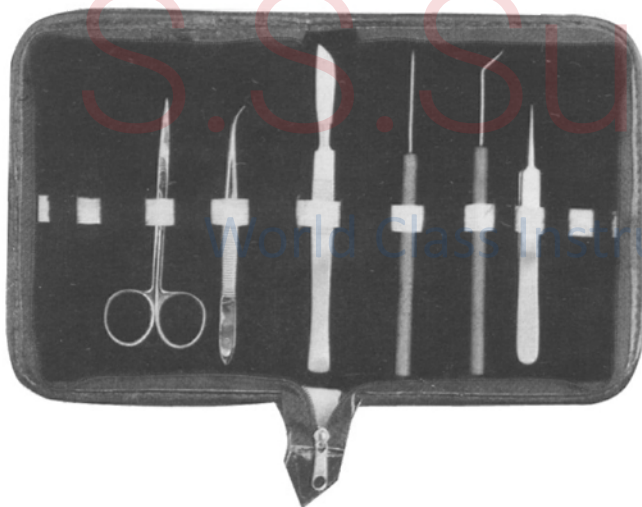

### 122-0011

- 1- IRIS SCISSOR STR
- 2- DISSECTING FORCEP CVD FINE 12 CM
- 3- SCALPEL
- 4- TEASING NEEDLE STR WOODEN HANDLE
- 5- TEASING NEEDLE CVD WOODEN HANDLE
- 6- WATCHMAKER FINE POINT



### 122-0012

- 1- DISSECTING FORCEP FINE STR WITH PIN 12 CM
- 2- IRIS SCISSOR STR
- 3- PROBE WITH EYE
- 4- PROBE AND HOOK
- 5- OPERATING SCISSOR S/B STR 14 CM
- 6- TRIPLE CHAIN HOOK
- 7- B.P. HANDLE NO. 4
- 8- HUBER PROBE
- 9- B.P. HANDLE NO. 3
- 10- TASING NEEDLE STR PLASTIC HANDLE
- 11- TASING NEEDLE CVD PLASTIC HANDLE
- 12- GROOVED DIRECTOR AND TONGUE TIE
- 13- PROBE DOUBLE END

## ●●● Dissection Instruments

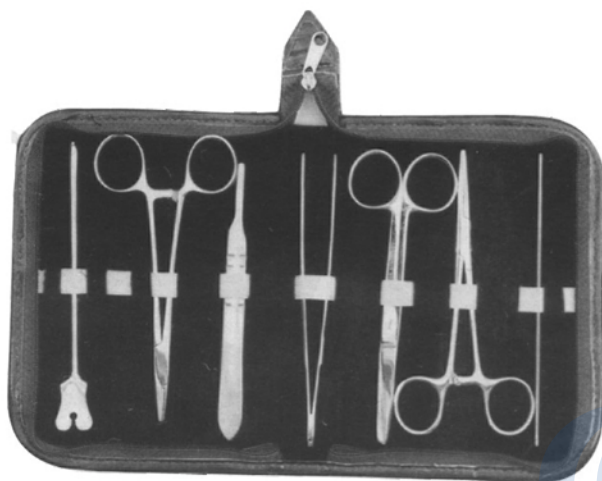

### 122-0013

- 1- GROOVED DIRECTOR AND TONGUE TIE
- 2- MAYO HEGAR NEEDLE HOLDER 14 CM.
- 3- BP. HANDLE NO.4
- 4- DISSECTING FORCEP THUMB 14 CM.
- 5- OPERATING SCISSOR S/B STR 14 CM.
- 6- KELLY FORCEP 14 CM STR
- 7- PROBE DOUBLE END



### 122-0014

- 1- DISSECTING FORCEP THUMB 14 CM
- 2- DISSECTING FORCEP 1x2 TEETH 14 CM
- 3- BP. HANDLE NO. 3
- 4- GROOVED DIRECTOR AND TONGUE TIE
- 5- MAYO HEAGR NEEDLE HOLDER 14 CM.
- 6- OPERATING SCISSOR S/B STR 14 CM.
- 7- PROBE DOUBLE END
- 8- KELLY FORCEP STR 14 CM.



### 122-0015

- 1- PROBE DOUBLE END
- 2- B.P. HANDLE NO. 4
- 3- DISSECTING FORCEP 1x2 TEETH 14 CM.
- 4- OPERATING SCISSOR S/B 14 CM STR.
- 5- MAYO HEAGR NEEDLE HOLDER 14 CM.
- 6- KELLY FORCEP STR 14 CM.
- 7- OPERATING SCISSOR S/B CVD 14 CM.
- 8- GROOVED DIRECTOR AND TONGUE TIE
- 9- DISSECTING FORCEP THUMB 14 CM.



### 122-0016

- 1- PROBE DOUBLE END
- 2- DISSECTING FORCEP 1x2 TEETH 14 CM.
- 3- KELLY FORCEP CVD 14 CM.
- 4- OPERATING SCISSOR S/B 14 CM CVD.
- 5- MAYO HEAGR NEEDLE HOLDER 14 CM.
- 6- B.P. HANDLE NO.4
- 7- OPERATING SCISSOR S/B 14 CM STR.
- 8- KELLY FORCEP STR. 14 CM.
- 9- DISSECTING FORCEP THUMB 14 CM
- 10- GROOVED DIRECTOR AND TONGUE TIE





123-0001

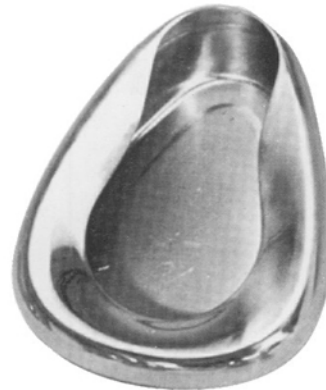

123-0002



123-0008

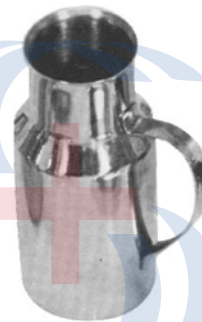

123-0007

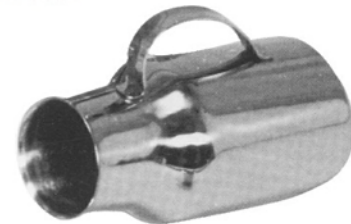

123-0006

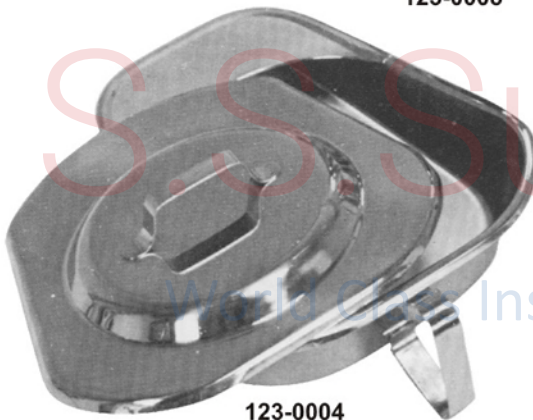

123-0004

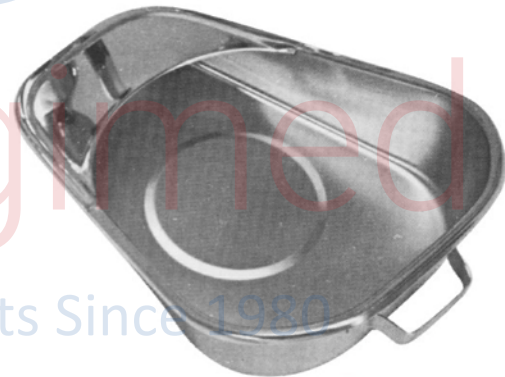

123-0003  
123-0005

**BED PANS, Perfection Type**

INSTRUMENTS #		LENGTH		WIDTH		FRONT	HEIGHT	BACK	
123-0001	Adult	14"	355mm	11-3/8"	290mm	4-3/8"	110mm	2-5/8"	67mm
123-0002	Child	12-1/8"	308mm	9-3/4"	80mm	3-1/8"	80mm	1-3/4"	45mm

**BED PANS, Practure Type**

123-0003		11-7/8"	300mm	9-1/4"	235mm	2-7/8"	72mm	1"	25mm
123-0004		Same as above but with cover							
123-0005	Large	14-1/8"	360mm	10"	255mm	3- 1/8"	90mm	1"	25mm

**URINALS MALE**

		CAPACITY		DIAMETER		HEIGHT	
123-0006	Horizontal	1-3/4" Qts.	1.7" Qts.	4-1/2"	115mm	9-1/2"	240mm
123-0007	Upright Junior	1.0 Qts.	0.9 Qts.	3-3/4"	95mm	8"	203mm
123-0008	Upright Adult	1.5/8 Qts.	1.5 Qts.	4"	100mm	8-7/8"	225mm



## ●●● Patient Treatment Items

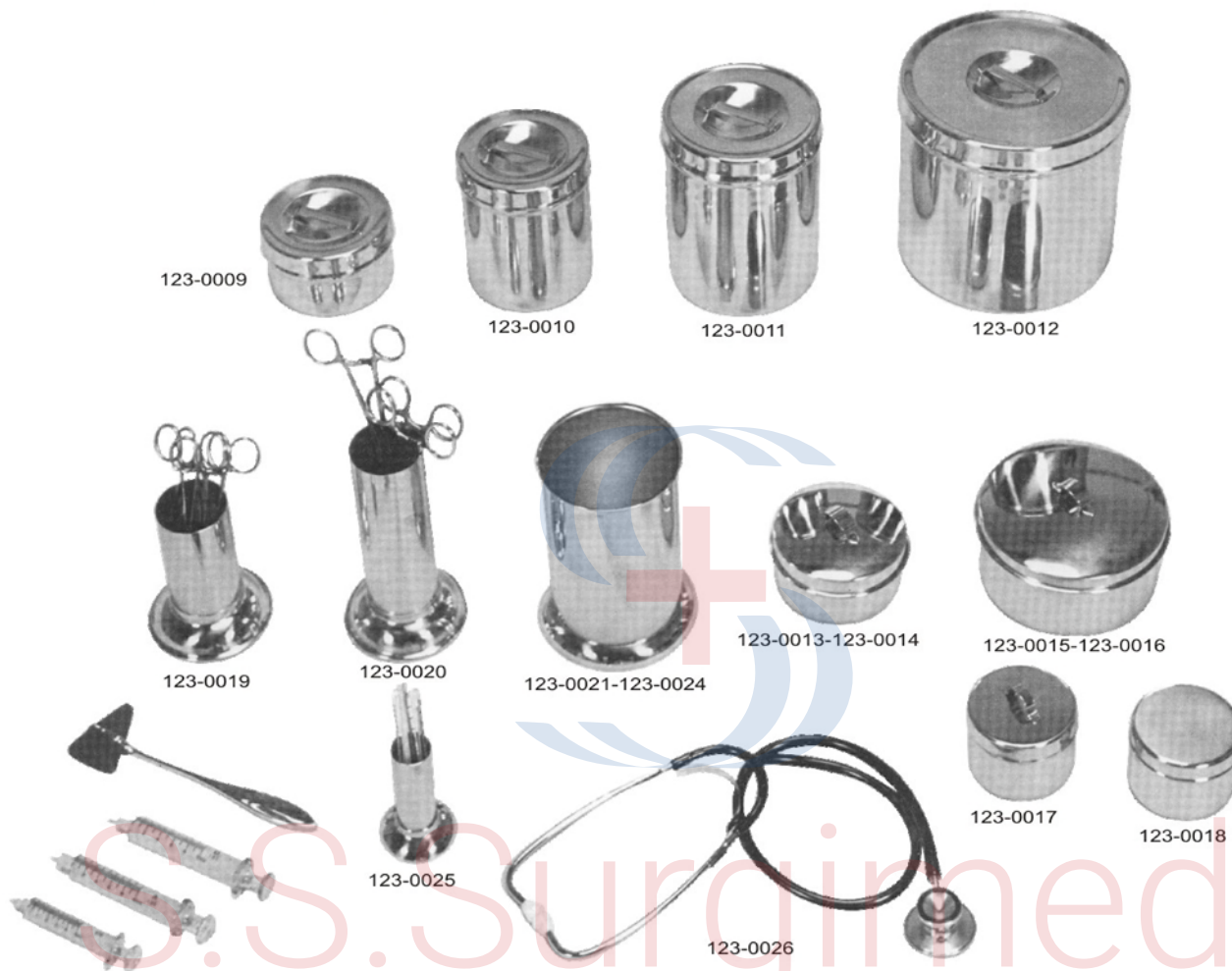

### PATIENT TREATMENT ITEMS

#### DRESSING JARS w/cover

CAT. No.	Capacity	Diameter	Height
123-0009	½ Qt. 0.47l	4-1/8" 105mm	2-3/8" 60mm
123-0010	1Qt. 0.95l	4-1/8" 105mm	5-1/4" 135mm
123-0011	2-1/4 Qts. 2.13l	4-7/8" 125mm	6-3/4" 170mm
123-0012	4-½ Qts. 4.26l	7-1/4" 185mm	6-7/8" 175mm
123-0013	5/16 Qt. 0.32l	3-1/2" 90mm	2-1/8" 55mm
123-0014	7/16 Qt. 0.4l	4" 100mm	2-1/4" 57mm
123-0015	11/16 Qt. 0.67l	4-3/4" 120mm	2-3/8" 61mm
123-0016	1-1/16 Qts. 1.0l	5-1/2" 140mm	3" 75mm

#### NEEDLE/OINTMENT JARS w/cover

123-0017	1/4 Qt. 0.24l	3" 75mm	2-1/2" 65mm
123-0018 - Same as above but with plain cover-			

#### FORCEPS JARS w/Heavy base and Light base

CAT. No.	Tube Diameter	Base Diameter	Height
123-0019 Heavy base	2-1/8" 55mm	4" 100mm	4-1/2" 115mm
123-0020 Heavy base	2-1/8" 55mm	4" 100mm	7-1/4" 185mm
123-0021 Light base	2-3/8" 60mm	3-1/8" 80mm	4" 100mm
123-0022 Light base	3" 75mm	3-3/4" 95mm	4-3/4" 120mm
123-0023 Light base	3-1/28" 90mm	4-1/2" 115mm	6-1/8" 155mm
123-0024 Light base	4" 100mm	4-7/8" 125mm	6-3/4" 170mm

#### THERMOMETER JAR

123-0025	1" 25mm	2-1/8" 55mm	4" 100mm
----------	---------	-------------	----------

#### STETHOSCOPES

123-0026	Combination Stethoscope chest piece turnable, light meta, one side with diaphragm, other side bell type	Chest piece only, ø 47mm
----------	---	--------------------------



S.S. Surgimed

World Class Instruments Since 1980

# SURGICAL INSTRUMENTS

## Treatment Room Items ●●●

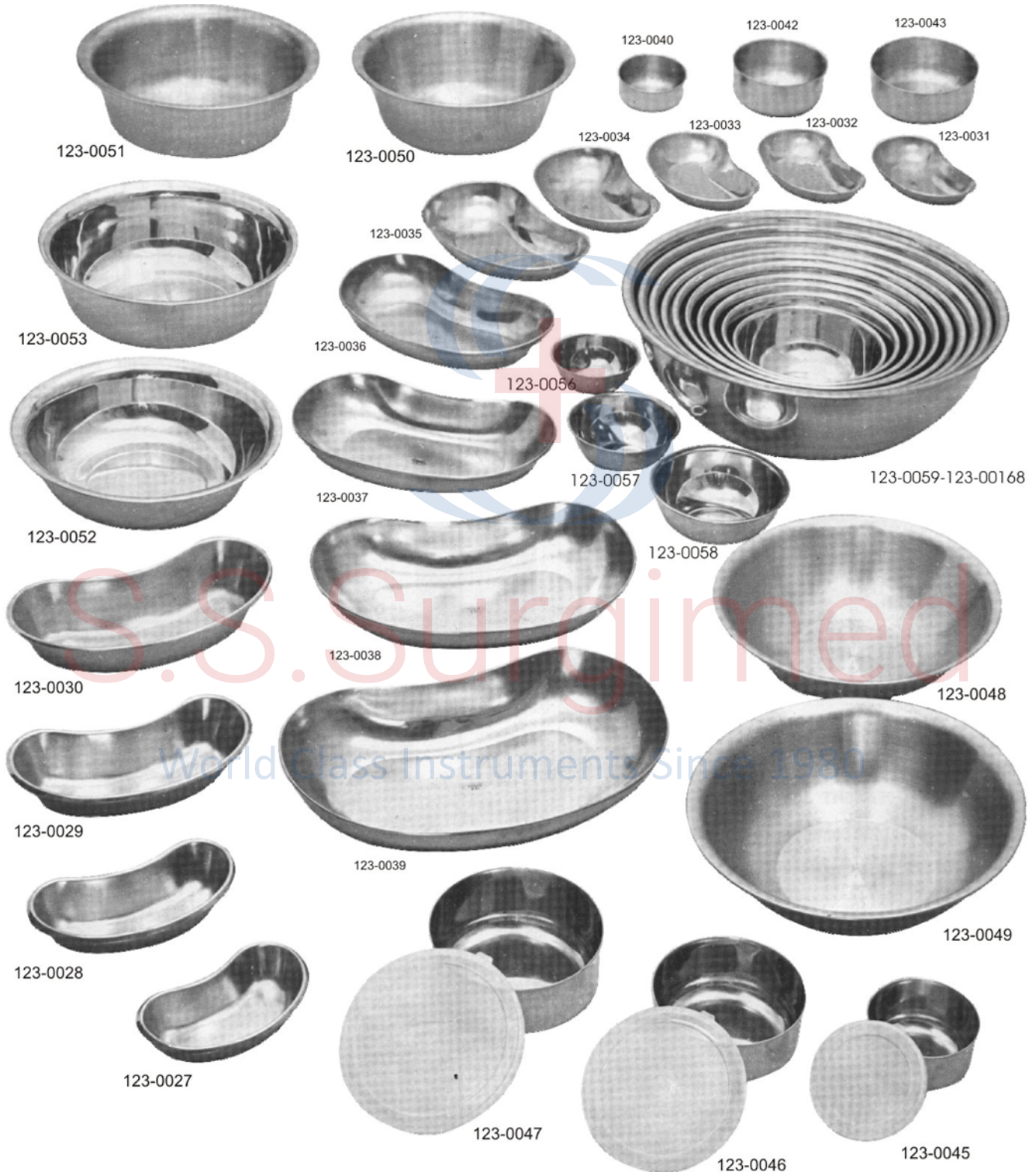





## ●●● Treatment Room Items

### **EMESIS BASINS (Kidney trays), deep**

INSTRUMENTS #	LENGTH		WIDTH		DEPTH	
123-0027	6"	150mm	3-1/2"	90mm	1-1/2"	40mm
123-0028	8"	205mm	3-3/4"	95mm	1-3/4"	45mm
123-0029	10"	255mm	4-1/2"	115mm	2-1/8"	55mm
123-0030	12"	305mm	5-1/2"	140mm	2-1/2"	65mm

### **EMESIS BASINS (Kidney Trays), shallow, light gauge**

123-0031	7-7/8"	200mm	4-3/8"	110mm	1-1/4"	30mm
123-0032	8-1/2"	215mm	4-1/2"	115mm	1-3/8"	35mm
123-0033	9"	230mm	5"	125mm	1-3/8"	35mm
123-0034	9-5/8"	245mm	5-1/2"	140mm	1-5/8"	40mm
123-0035	11-1/4"	285mm	6-1/4"	160mm	1-3/4"	45mm
123-0036	12-3/8"	315mm	6-7/8"	175mm	2"	50mm
123-0037	13"	330mm	7-1/4"	185mm	2-1/8"	55mm
123-0038	14-5/8"	370mm	8-1/2"	215mm	2-3/8"	60mm
123-0039	16-1/8"	410mm	9-5/8"	245mm	2-1/2"	65mm

### **SPONGE BOWLS**

INSTRUMENTS #	CAPACITY		DIAMETER		DEPTH	
123-0040	3/8 Qt.	0.36	4-1/8"	105mm	2"	50mm
123-0041	5/8 Qt.	0.6	5"	125mm	2-1/4"	57mm
123-0042	1.0 Qt.	0.95	5-3/4"	145mm	2-1/2"	65mm
123-0043	1-3/8 Qts.	1.3	6-1/2"	165mm	3"	75mm
123-0044	1-7/8 Qts.	1.78	7-3/8"	187mm	3"	75mm

### **SPONGE BOWLS w/plastic cover 18.0 s.s.**

123-0045	3/8 Qt.	0.36	4"	100mm	2-1/8"	55mm
123-0046	7/8 Qt.	0.8	5-1/2"	140mm	2-1/2"	65mm
123-0047	1-3/8 Qts.	1.3	6-1/2"	165mm	2-3/4"	70mm

### **WASH BASINS**

123-0048	3-7/8 Qts.	3.7	12-3/8"	315mm	3-1/8"	80mm
123-0049	4-3/4 Qts.	4.5	13-1/4"	335mm	3-5/8"	90mm

### **SOLUTION BASINS**

123-0050	7 Qts.	6.6	13-5/8"	345mm	4-5/8"	115mm
123-0051	8-1/2 Qts.	8.0	14-1/2"	370mm	4-3/4"	120mm
123-0052	4-1/2 Qts.	4.2	12-5/8"	320mm	3-1/8"	80mm
123-0053	5-3/4 Qts.	5.4	12-5/8"	320mm	4-1/8"	105mm
123-0054	6-1/2 Qts.	6.2	13-3/8"	340mm	4-3/8"	110mm
123-0055	8 Qts.	7.6	14-1/8"	360mm	4-5/8"	118mm

### **LOTION BOWLS, 18,8 s,s or 18.0 s.s.**

123-0056	1/4 Qt.	0.24	4-1/8"	105mm	1-3/4"	45mm	
123-0057	7/16 Qt.	0.4	5-1/8"	130mm	2-1/8"	55mm	
123-0058	3/4 Qt.	0.7	5-7/8"	150mm	2-3/8"	60mm	
123-0059	1-1/4 Qts.	1.2	7-1/8"	180mm	2-3/4"	70mm	
123-0060	2-1/8 Qts.	2.0	8-1/4"	210mm	3-1/2"	90mm	
123-0061	3-3/16 Qts.	3.0	9-1/2"	240mm	4"	100mm	
123-0062	3-3/4 Qts.	4.5	10-5/8"	270mm	4-1/8"	105mm	
123-0063	6-7/8 Qts.	6.5	11-3/4"	300mm	4-3/4"	120mm	
123-0064	8-7/16 Qts.	8.0	13"	330mm	4-7/8"	125mm	
123-0065	10 Qts.	9.5	14-1/8"	360mm	5-1/4"	135mm	
123-0066	13-1/8 Qts.	12.5	15-3/8"	390mm	5-3/4"	145mm	
123-0067	15-5/16 Qts.	15.5	16-1/2"	420mm	6-1/8"	155mm	
123-0068	21-1/8 Qts.	20.0	17-3/4"	450mm	6-3/4"	170mm	
123-0069	Deep not Illustratea	1-3/16 Qts.	1.1	6-1/4"	150mm	3-3/8"	85mm
123-0070	Deep not Illustratea	1-5/16 Qts.	1.8	7-1/8"	180mm	4"	100mm
123-0071	Deep not Illustratea	3-1/8 Qts.	3.0	8-1/4"	210mm	4-1/2"	115mm
123-0072	Deep not Illustratea	4-7/16 Qts.	4.2	9-1/2"	240mm	5-1/8"	130mm



S.S. Surgimed

World Class Instruments Since 1980

# SURGICAL INSTRUMENTS

## Treatment Room Items ●●●

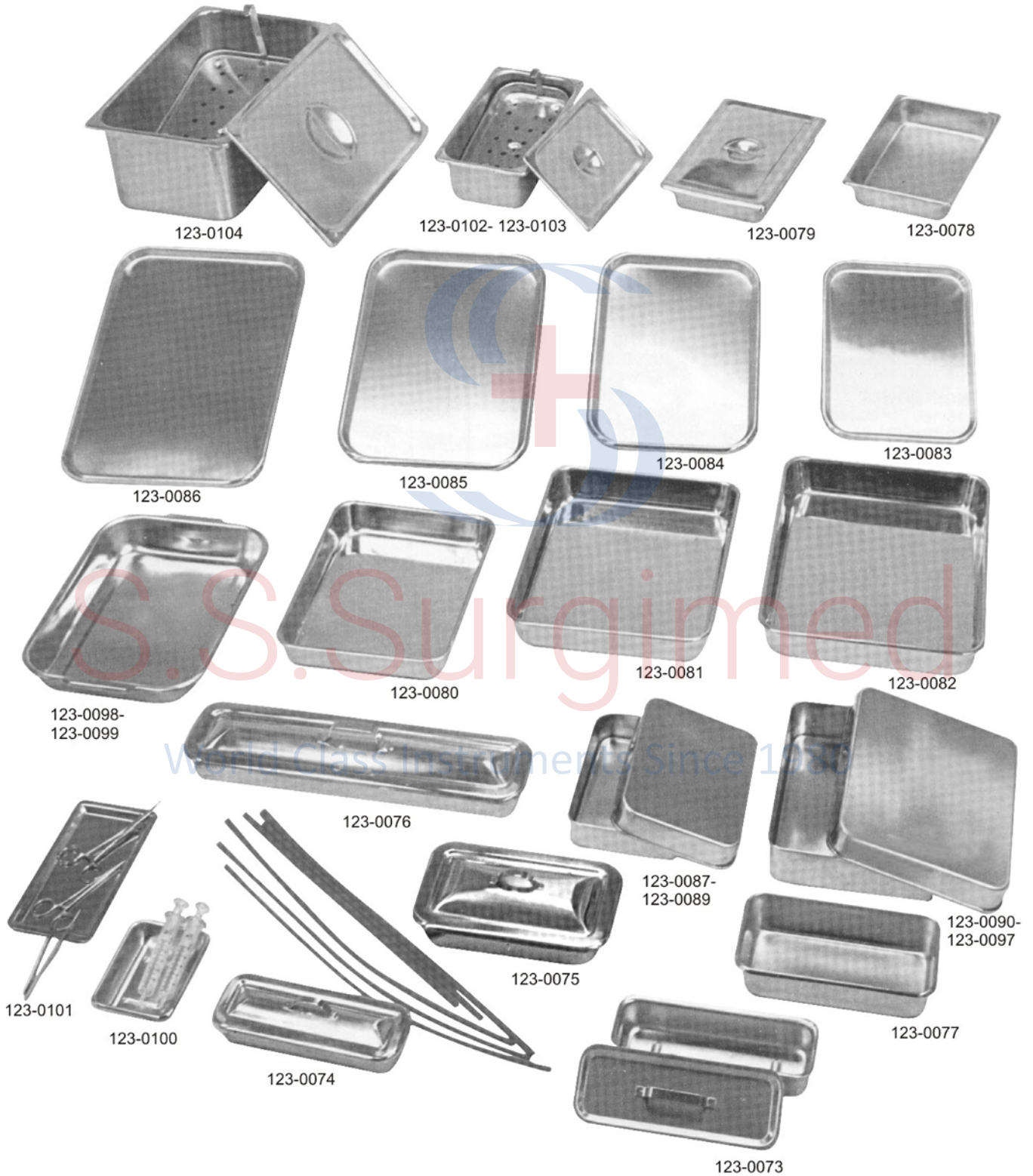



●●● Treatment Room Items

## TREATMENT ROOM ITEMS

### CATHETER TRAYS w/cover

CAT. No.	Length		Width		Depth	
123-0073	8-3/4"	222mm	3-1/4"	82mm	1-5/8"	40mm
123-0074	8-1/2"	215mm	3"	75mm	1-1/2"	38mm
123-0075	8-7/8"	225mm	5"	125mm	2"	50mm
123-0076	17"	430mm	4"	100mm	2-1/8"	55mm

### INSTRUMENT TRAYS

123-0077	8-7/8"	225mm	5"	125mm	2"	50mm
123-0078	12-1/4"	310mm	7-5/8"	195mm	2-1/8"	55mm
123-0079 w/cover	- Same as above -					
123-0080	12-5/8"	320mm	9"	320mm	1-3/4"	45mm
123-0081	14-1/8"	360mm	10-5/8"	270mm	2"	50mm
123-0082	16-1/8"	410mm	11-3/8"	290mm	2-1/8"	55mm

### INSTRUMENT TRAYS, Shallow

123-0083	13-1/2"	345mm	9-3/4"	245mm	5/8"	16mm
123-0084	15-1/8"	385mm	10-1/2"	265mm	5/8"	16mm
123-0085	17"	340mm	11-5/8"	295mm	5/8"	16mm
123-0086	19"	485mm	12-1/2"	320mm	5/8"	16mm

### INSTRUMENT TRAYS w/set cover

123-0087	8-1/4"	210mm	6"	150mm	1-5/8"	40mm
123-0088	9-1/2"	240mm	7-1/8"	180mm	1-5/8"	40mm
123-0089	9-1/2"	240mm	7-1/8"	180mm	2-3/8"	60mm
123-0090	10-5/8"	270mm	8-1/4"	210mm	1-5/8"	40mm
123-0091	10-5/8"	270mm	8-1/4"	210mm	2-3/8"	60mm
123-0092	11-7/8"	300mm	9-1/2"	240mm	1-5/8"	40mm
123-0093	11-7/8"	300mm	9-1/2"	240mm	2-3/8"	60mm
123-0094	13"	330mm	10-5/8"	270mm	1-5/8"	40mm
123-0095	13"	330mm	10-5/8"	270mm	2-3/8"	60mm
123-0096	14-1/8"	360mm	11-7/8"	300mm	1-5/8"	40mm
123-0097	14-1/8"	360mm	11-7/8"	300mm	2-3/8"	60mm

### INSTRUMENT TRAYS w/tab handle

123-0098	14-7/8"	375mm	10-1/8"	255mm	2"	50mm
123-0099	16-1/8"	410mm	11-1/8"	280mm	2"	50mm

### STERILIZING TRAYS

123-0100	Syringe	5-1/4"	135mm	4"	100mm	1"	25mm
123-0101	Needle	8-1/2"	215mm	4-1/2"	115mm	3/8"	10mm

### STERILIZERS, INSTRUMENTS, for fuel heat, including container, perforated lift-out tray and flat cover.

123-0102	12-5/8"	320mm	6-7/8"	175mm	4"	100mm
123-0103	16-3/8"	415mm	9-7/8"	250mm	4"	100mm
123-0104	17-3/4"	450mm	10-5/8"	270mm	7-1/8"	180mm





INDEX

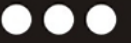

A

<b>American Pattern</b> (Scissors)	10
<b>Aufricht</b> (Scissors)	10
<b>Adson</b> (Delicate Dissecting Forceps)	17,8
<b>Adson-brown</b> (Delicate Dissecting Forceps)	8
<b>Arthure</b> (Splinter Forceps)	22
<b>Adson-brown</b> (Delicate Dissecting Forceps)	18
<b>Arthure</b> (Splinter Forceps)	22
<b>Allis</b> (Tissue Forceps)	26
<b>American Pattern Allis</b> (Tissue Forceps)	26
<b>Arruga</b> (Micro)	43
<b>Anel Lachrymal</b> (Probes)	49
<b>Auward</b> (Vaginal Retractor)	75
<b>Alexander</b> (Cervical Biopsy Forceps)	81
<b>Adson Frazier</b> (Suction Tubes)	95
<b>Adson</b> (Suction Tubes)	95
<b>Amputation Saw</b> (Amputation Instruments)	96
<b>Army Regulation Amputation Saw</b> (Amputation Instruments)	96
<b>Adson</b> (Bone Levers & Raspatories)	98
<b>Aneurysm Clamp</b> (Atrauma Cardiovascular Forceps)	122

B

<b>Barron</b> (Surgical Handles)	05
<b>Braun Stadler</b> (Scissors)	10
<b>Bonney</b> (Serrated Dissecting Forceps)	16
<b>Bickford</b> (Serrated Dissecting Forceps)	16
<b>Bonney</b> (Toothed Dissecting Forceps)	20
<b>Bickford</b> (Toothed Dissecting Forceps)	20
<b>Baby - Adson</b> (Dissecting & Ligature Forceps)	23
<b>Babcock</b> (Tissue Forceps)	25
<b>Ball And Socket</b> (Towel Clamps)	29
<b>Backhaus</b> (Towel Clamps)	29
<b>Bozemann Uterine</b> (Dressing Forceps)	31
<b>Bozemann</b> (Dressing Forceps)	31
<b>Baby - Crile</b> (Haemostats Forceps)	32,33
<b>Birkett</b> (Haemostats Forceps)	40
<b>Barraquer</b> (Micro)	43
<b>Brodie</b> (Probes)	48
<b>Balfour Abdominal</b> (Hand Held Retractors)	60
<b>Berkeley Abdominal</b> (Hand Held Retractors)	62
<b>Brown</b> (Tenaculum Forceps)	78
<b>Bonney Polypi</b> (Ovum Forceps)	80
<b>Bumm</b> (Uterine Cannulae)	85
<b>Bonney</b> (Hysterectomy Clamps)	90
<b>Bladder Spatula</b> (Urology)	92
<b>Barron</b> (Suction Tubes)	95
<b>Belucci</b> (Suction Tubes)	95
<b>Boyd Bone Curette</b> (Bone Levers & Raspatories)	98
<b>Burns</b> (Bone Holding Forceps)	101
<b>Beyer</b> (Bone Rongeurs)	103
<b>Beyer</b> (Bone Rongeurs)	105
<b>Beck Rongeur</b> (Disc Rongeurs)	107
<b>Burford</b> (Rib Spreaders)	111
<b>Bainbridge</b> (Atrauma Cardiovascular Forceps)	121
<b>Beck</b> (Atrauma Cardiovascular Forceps)	127
<b>Bipolar Forceps</b> (Bipolar Forceps)	129,130
<b>Blades</b>	132
(Monopolar Handles,Blades,Needle,Turner Warwick Scissors)	

C

<b>Crafoord</b> (Scissors)	09
<b>Counter Scissors</b> (Scissors)	13
<b>Canadian</b> (Serrated Dissecting Forceps)	15
<b>Cairns Dott</b> (Delicate Dissecting Forceps)	17
<b>Canadian</b> (Toothed Dissecting Forceps)	20
<b>Chaput Poirier</b> (Tissue Forceps)	26

<b>Collin Tongue Forceps</b> (Tongue Depressors)	28
<b>Cushing</b> (Haemostats Forceps)	34
<b>Crafoord</b> (Haemostats Forceps)	34
<b>Cairns</b> (Haemostats Forceps)	34
<b>Crile</b> (Haemostats Forceps)	34,35
<b>Castroviejo</b> (Micro)	43
<b>Converse</b> (Needle Holders)	43
<b>Crile Wood</b> (Needle Holders)	44
<b>Crile Murray</b> (Needle Holders)	44
<b>Cawthorne</b> (Probes)	49
<b>Charnley Suture</b> (Suture Instruments)	51
<b>Cushings Vein</b> (Hand Held Retractors)	57
<b>Cone</b> (Hand Held Retractors)	64
<b>Cusso</b> (Vaginal Speculum)	72
<b>Czerny Rectal Speculum</b> (Proctology)	91
<b>Clutton Urethral Sounds</b> (Urology)	93
<b>Cone Suction Tubes</b> (Suction Tubes)	95
<b>Collier And Morris</b> (Bone Scoops)	99
<b>Cairns</b> (Bone Rongeurs)	103
<b>Cushing Cairns</b> (Disc Rongeurs)	107
<b>Cushing Rongeur</b> (Disc Rongeurs)	107
<b>Cooley</b> (Rib Spreaders)	110
<b>Cooley</b> (Atrauma Cardiovascular Forceps)	117
<b>Cooley</b> (Atrauma Tissue Forceps)	118
<b>Cooley</b> (Vascular Dilators)	128

D

<b>Dressing</b> (Scissors)	08
<b>Doyen Abdominal</b> (Scissors)	13
<b>Dissecting Forceps</b> (Serrated Dissecting Forceps)	15
<b>Dissecting Forceps</b> (Delicate Dissecting Forceps)	18
<b>Dissecting Forceps</b> (Toothed Dissecting Forceps)	19
<b>Denis Browne</b> (Splinter Forceps)	22
<b>Doyen Child</b> (Mouth Gags)	27
<b>Doyen Dult</b> (Mouth Gags)	27
<b>Doyen</b> (Towel Clamps)	29
<b>Dunhill</b> (Haemostats Forceps)	37
<b>Derf</b> (Needle Holders)	43
<b>Directors</b> (Probes)	48
<b>Deaver</b> (Hand Held Retractors)	52
<b>Deaver Grip</b> (Hand Held Retractors)	53
<b>Durham</b> (Hand Held Retractors)	56
<b>Doyen</b> (Hand Held Retractors)	59
<b>Doyen</b> (Intestinal Clamps)	67
<b>Doyen Kocher</b> (Intestinal Clamps)	68
<b>Doyen Mayo Robson</b> (Intestinal Clamps)	68,69
<b>Doyen</b> (Vaginal Speculum)	74
<b>Doyen</b> (Ovum Forceps)	80
<b>De Lee</b> (Obstetrics Instruments)	86
<b>Dingman</b> (Bone Holding Forceps)	102
<b>De Vilbiss</b> (Bone Cutting Forceps)	108
<b>De-bakey Satinsky</b> (Atrauma Bulldog Clamps)	113
<b>De Bakey-carotis</b> (Atrauma Bulldog Clamps)	113
<b>De Bakey Satinsky</b> (Atrauma Bulldog Clamps)	113
<b>Debakey Bulldog</b> (Atrauma Bulldog Clamps)	113
<b>Debakey Bulldog Clamps</b> (Atrauma Bulldog Clamps)	113
<b>De Bakey-rankin</b> (Atrauma Hemostatic)	114
<b>De Bakey-mosquito</b> (Atrauma Hemostatic)	114
<b>Dietrich</b> (Cardiovascular Forceps)	114
<b>Dale</b> (Atrauma Cardiovascular Forceps)	115
<b>De Bakey</b> (Atrauma Tissue Forceps)	118
<b>De Bakey</b> (Atrauma Cardiovascular Forceps)	120,121,123
	124,125
<b>De Bakey</b> (Vascular Dilators)	128
<b>Dissecting Forceps</b> ( Monopolar Cables)	131
<b>Derra</b> (Atrauma Cardiovascular Forceps)	127
<b>Dissection Sets</b> (Dissection Instruments)	133,134,135,136

## INDEX

### E

<b>Ent Complete</b> (Diagnostic Set)	01
<b>Ergonomic</b> (Surgical Handles)	04
<b>Emmet</b> (Serrated Dissecting Forceps)	16
<b>Edna Lorna</b> (Towel Clamps)	29
<b>Elliot</b> (Obstetrics Instruments)	86
<b>Echlin</b> (Bone Rongeurs)	105

### F

<b>Favaloro</b> (Scissors)	13
<b>Feilchenfel</b> (Splinter Forceps)	22
<b>Fine Curved Dissecting</b> (Dissecting & Ligature Forceps)	23
<b>Fergusson Acland</b> (Mouth Gags)	27
<b>Featherstone</b> (Mouth Gags)	27
<b>Flat</b> (Tongue Depressors)	28
<b>Forester</b> (Sponge Holding Forceps)	30
<b>Fraser - Adson</b> (Haemostats Forceps)	37
<b>Fraser-kelly</b> (Crile Haemostats Forceps)	37
<b>Fickling Oral</b> (Haemostats Forceps)	41
<b>Fistula Probe</b> (Probes)	49
<b>Farabeuf</b> (Hand Held Retractors)	58
<b>Faure</b> (Peritoneum)	89
<b>Female Catheters</b> (Urology)	93
<b>Frazier</b> (Suction Tubes)	95
<b>Formby</b> (Suction Tubes)	95
<b>Finger Saw</b> (Amputation Instruments)	96
<b>Farabeuf</b> (Bone Levers & Raspatories)	97
<b>Freer Elevator</b> (Bone Levers & Raspatories)	97
<b>Fergusson</b> (Bone Holding Forceps)	100
<b>Finocchietto - Infant</b> (Rib Spreaders)	110
<b>Finocchietto</b> (Rib Spreaders)	110
<b>Finocchietto-baby</b> (Rib Spreaders)	110

### G

<b>Gillies</b> (Toothed Dissecting Forceps)	19
<b>Grey Turner</b> (Haemostats Forceps)	34
<b>Gillies</b> (Needle Holders)	45
<b>Gwynne Evans Tonsil</b> (Dissectors)	51
<b>Gosset</b> (Hand Held Retractors)	61
<b>Goligher</b> (Hand Held Retractors)	62
<b>Geary Grant</b> (Cholecystectomy & Gall Stone)	65
<b>Gall Duct Scissors</b> (Cholecystectomy & Gall Stone)	66
<b>Grave</b> (Vaginal Speculum)	72
<b>Galabin</b> (Probes)	76
<b>Green - Armytage Haemostasis Forceps</b> (Dermatology)	88
<b>Gwilliam</b> (Hysterectomy Clamps)	89
<b>Gabriel Rectal Speculum</b> (Proctology)	91
<b>Gillies</b> (Suction Tubes)	94
<b>Gigli Saw With Handle</b> (Bone Rongeurs)	106
<b>Gregory-soft</b> (Atrauma Bulldog Clamps)	113
<b>Glover</b> (Atrauma Cardiovascular Forceps)	119,127
<b>Gregory</b> (Atrauma Cardiovascular Forceps)	115

### H

<b>Hegemann's Delicate</b> (Scissors)	10
<b>Hegemann Turbinectomy</b> (Delicate Scissors)	11
<b>Hedgeman</b> (scissors)	13
<b>Hunter</b> (Splinter Forceps)	22
<b>Heywood-smith Tongue Forceps</b> (Tongue Depressors)	28
<b>Halstead Mosquito</b> (Haemostats Forceps)	32,33
<b>Heiss</b> (Haemostats Forceps)	40
<b>Heaney</b> (Needle Holders)	45
<b>Hegar</b> (Needle Holders)	46
<b>Halsey</b> (Needle Holders)	46

<b>Hawkin Ambler</b> (Uterine Dilators)	75
<b>Hegar</b> (Uterine Dilators)	75,76
<b>Hegar</b> (Uterine Dilators Complete Sets)	77
<b>Heywood Smith</b> (Ovum Forceps)	79
<b>Heany</b> (Hysterectomy Clamps)	89
<b>Hysterectomy Forceps</b> (Hysterectomy Clamps)	90
<b>Herrick</b> (Urology)	93
<b>House</b> (Suction Tubes)	95
<b>Handle</b> (Suction Tubes)	95
<b>Howarth</b> (Bone Levers & Raspatories)	97
<b>Heath</b> (Mallets)	100
<b>Hey Groves</b> (Bone Holding Forceps)	101
<b>Hartmann</b> (Bone Rongeurs)	103
<b>Heanley</b> (Bone Rongeurs)	104
<b>Handles</b> (Monopolar Handles, Blades, Needle, Turner Warwick Scissors)	132

### I

<b>Iris</b> (Delicate Scissors)	11
<b>Irwin</b> (Hand Held Retractors)	62
<b>I.u.d. Removing Hook</b> (Obstetrics Instruments)	86

### J

<b>Jefferson</b> (Delicate Dissecting Forceps)	18
<b>Jackson Burrows</b> (Toothed Dissecting Forceps)	21
<b>Jud-allis</b> (Tissue Forceps)	26
<b>Jameson</b> (Needle Holders)	45
<b>Jobson Horne</b> (Probes)	49
<b>Janson Shea</b> (Hand Held Retractors)	64
<b>Jefferson</b> (Hand Held Retractors)	64
<b>Joseph</b> (Bone Levers & Raspatories)	97
<b>Jacobson</b> (Bone Scoops)	99
<b>Jansen-middleton Septum Forceps</b> (Bone Rongeurs)	103
<b>Jansen</b> (Bone Rongeurs)	103
<b>Javid</b> (Atrauma Cardiovascular Forceps)	115
<b>Jeweler Forceps</b> (Bipolar Forceps)	129

### K

<b>Kilner</b> (Hcissors)	10
<b>Kelly-crile</b> (Haemostats Forceps)	35
<b>Kelly</b> (Haemostats Forceps)	35
<b>Kelly Halstead</b> (Haemostats Forceps)	35
<b>Kocher</b> (Haemostats Forceps)	35,36
<b>Kilner</b> (Needle Holders)	44
<b>Kings College Hospital Cocainising Wire</b> (Probes)	49
<b>Kocher Thyroid</b> (Dissectors)	50
<b>Kocher Thyroid</b> (Dissectors)	50
<b>King</b> (Dissectors)	50
<b>Kelly</b> (hand Held Retractors)	55
<b>Kocher</b> (Hand Held Retractors)	56,57,58
<b>Kocher Bone Hook</b> (Hand Held Retractors)	60
<b>Kirschner Retractor Set</b> (Hand Held Retractors)	61
<b>Kirschner Retractor Frame</b> (Hand Held Retractors)	61
<b>Kirschner Retractor Blades</b> (Hand Held Retractors)	61
<b>Kocher</b> (Intestinal Clamps)	68
<b>Kristelle</b> (Vaginal Speculum)	73
<b>Kogan Endocervical</b> (Vaginal Speculum)	74
<b>Kevorkian</b> (Cervical Biopsy Forceps)	82
<b>Kielland</b> (Obstetrics Instruments)	86
<b>Kelly Proctoscope</b> (Proctology)	91
<b>Kidney Clamp</b> (Urology)	92
<b>Kelsey Fry</b> (mallets)	100
<b>Killearn</b> (Bone Rongeurs)	105





## INDEX



### L

<b>Lloyd Davis Rectal</b> (Scissors)	09
<b>Lister Bandage</b> (Scissors)	14
<b>Lane</b> (Delicate Dissecting Forceps)	18
<b>Ligature Forceps</b> (Dissecting & Ligature Forceps)	23
<b>Lawrence</b> (Dissecting & Ligature Forceps)	24
<b>Long Curved</b> (Dissecting & Ligature Forceps)	24
<b>Lane</b> (Tissue Forceps)	25
<b>Lack Tongue Depressor</b> (Tongue Depressors)	28
<b>Lister - Sinus</b> (Dressing Forceps)	31
<b>Lloyd Davis</b> (Haemostats Forceps)	36
<b>Lawrance</b> (Needle Holders)	47
<b>Liebrich Lachrymal</b> (Probes)	49
<b>Logan Turner</b> (Probes)	49
<b>Littauer</b> (Suture Instruments)	51
<b>Littauer Spencer</b> (Suture Instruments)	51
<b>Liver Retractors</b> (Hand Held Retractors)	55
<b>Langenbeck</b> (Hand Held Retractors)	57
<b>Lahey</b> (Cholecystectomy & Gall Stone)	65
<b>Lower</b> (Cholecystectomy & Gall Stone)	65
<b>Langenbeck Bone Hook</b> (Hand Held Retractors)	60
<b>Lane</b> (Intestinal Clamps)	69
<b>Lang Stevenson</b> (Intestinal Clamps)	70
<b>Lane Twin Anastomosis</b> (Intestinal Clamps)	71
<b>Leech Wilkinson</b> (Cervical Biopsy Forceps)	81
<b>Lempert</b> (Bone Scoops)	99
<b>Lucae</b> (Mallets)	100
<b>Lane</b> (Bone Holding Forceps)	101
<b>Lowman</b> (Bone Holding Forceps)	101
<b>Lewin</b> (Bone Holding Forceps)	102
<b>Luer</b> (Bone Rongeurs)	103
<b>Leksell</b> (Bone Rongeurs)	104
<b>Luer-jansen</b> (Bone Rongeurs)	105
<b>Liston Tudor Edwards</b> (Bone Cutting Forceps)	108
<b>Lovelace</b> (Tissue & Organ)	112
<b>Leland Jones</b> (Atrauma Cardiovascular Forceps)	121
<b>Lambert - Kay</b> (Atrauma Cardiovascular Forceps)	125

### M

<b>Miller</b> (Laryngoscope Set)	02
<b>Magill</b> (Catheter Forceps)	03
<b>Mcintosh</b> (Laryngoscope Set)	03
<b>Mayo</b> (Scissors)	06
<b>Mayo Harrington</b> (Scissors)	07
<b>Mayo Stille</b> (Scissors)	07
<b>Metzenbaum</b> (Scissors)	08
<b>Mcindoe Scissors</b> (Scissors)	14
<b>Maingot Intestinal</b> (Serrated Dissecting Forceps)	16
<b>Macindoe</b> (Delicate Dissecting Forceps)	17
<b>Micindoe</b> (Toothed Dissecting Forceps)	19
<b>Mustarde</b> (Toothed Dissecting Forceps)	21
<b>Micro Soft Touch Ring Tip</b> (Splinter Forceps)	22
<b>Micro Adson</b> (Dissecting & Ligature Forceps)	23
<b>Mixter</b> (Dissecting & Ligature Forceps)	24
<b>Mayo</b> (Towel Clamps)	29
<b>Moynihan</b> (Towel Clamps)	29
<b>Mayo</b> (Haemostats Forceps)	36
<b>Moynihan</b> (Haemostats Forceps)	40
<b>Mixter</b> (Haemostats Forceps)	40
<b>Mayo Dunhill</b> (Needle Holders)	43
<b>Mayo</b> (Needle Holders)	43,44
<b>Morris</b> (Hand Held Retractors)	54
<b>Moynihan</b> (Hand Held Retractors)	56
<b>Mayo</b> (Needle Holders)	46,47
<b>Mayo Baumgartner</b> (Needle Holders)	46
<b>Mayo Masson</b> (Needle Holders)	46
<b>Mathieu</b> (Needle Holders)	46

<b>Mathieu</b> (Needle Holders)	47
<b>Mcphails</b> (Needle Holders)	47
<b>Macdonald</b> (Dissectors)	50
<b>Middeldorpf</b> (Hand Held Retractors)	56
<b>Mixter</b> (Cholecystectomy & Gall Stone)	65
<b>Mills</b> (Cholecystectomy & Gall Stone)	66
<b>Moynihan</b> (Cholecystectomy & Gall Stone)	66
<b>Mouat Gall Bladder Lifting Forceps</b> (Cholecystectomy & Gall Stone)	66
<b>Mcgee Lateral Viginal Retractor</b> (Vaginal Speculum)	72
<b>Mathieu</b> (Vaginal Speculum)	74
<b>Modified Wertheim</b> (Vaginal Speculum)	74
<b>Martin</b> (Probes)	76
<b>McIntock</b> (Ovum Forceps)	79
<b>Mikulicz</b> (Peritoneum)	89
<b>Maingot</b> (Hysterectomy Clamps)	90
<b>Mcevedy</b> Rectal Speculum (Proctology)	91
<b>Millin</b> (Urology)	92
<b>Macdonald</b> (Bone Levers & Raspatories)	97
<b>Martini</b> (Bone Scoops)	99
<b>Macewen</b> (Bone Scoops)	99
<b>Mead</b> (Bone Rongeurs)	103
<b>Martin</b> (Atrauma Cardiovascular Forceps)	116
<b>Measuring</b> (Vascular Measuring Device)	117
<b>Morris De Bakey</b> (Atrauma Cardiovascular Forceps)	125
<b>Mcpherson</b> (Bipolar Forceps)	129
<b>Monopolar Cables</b> ( Monopolar Cables)	131
<b>Mcindoe</b> ( Monopolar Cables)	131

### N

<b>Nelson Lung Adhesion</b> (Toothed Dissecting Forceps)	21
<b>Negus Tonsil</b> (Tonsil Artery Forceps)	42
<b>Naunton Morga</b> (Needle Holders)	44
<b>Norfolk And Norwich</b> (Hand Held Retractors)	63
<b>Noto</b> (Ovum Forceps)	79
<b>Naegele</b> (Obstetrics Instruments)	86
<b>Naunton Morgan Sims Rectal Speculum</b> (Proctology)	91
<b>Northfield</b> (Bone Rongeurs)	104,105
<b>Needle</b> (Monopolar Handles,Blades,Needle,Turner Warwick Scissors)	132

### O

<b>Otoscope Set</b>	01
<b>Officer</b> (Toothed Dissecting Forceps)	21
<b>O'shaughnessy</b> (Haemostats Forceps)	41
<b>Olsen Hegar</b> (Needle Holders)	45
<b>Olivecrona</b> (Bone Rongeurs)	106
<b>Ochsner</b> (Cardiovascular Forceps)	114

### P

<b>Potts</b> (Scissors)	13
<b>Pennybacker</b> (Delicate Dissecting Forceps)	18
<b>Probe With Eye</b> (Probes)	48
<b>Payr</b> (Dissectors)	51
<b>Potts-de Martel</b> (Cholecystectomy & Gall Stone)	66
<b>Parker Kerr</b> (Intestinal Clamps)	70
<b>Payr</b> (Intestinal Clamps)	70
<b>Pederson</b> (Vaginal Speculum)	72
<b>Perotoneum</b> (Peritoneum)	89
<b>Phaneuf</b> (Hysterectomy Clamps)	90
<b>Pratt Rectal Speculum</b> (Proctology)	91
<b>Poole</b> (Suction Tubes)	94
<b>Percy Amputation Flap Retractor</b> (Amputation Instruments)	96

## INDEX

<b>Pennybacker</b> (Bone Levers & Raspatories)	98
<b>Pennybacker</b> (Bone Rongeurs)	104
<b>Plaster Shears</b> (Plaster Cast Removal Instruments)	109
<b>Price-thomas</b> (Bronchus)	112
<b>Potts</b> (Atrauma Cardiovascular Forceps)	119,120
<b>Patient Care Items</b> (Patient Care Items)	137
<b>Patient Treatment Items</b> (Patient Treatment Items)	138

### R

<b>Reynolds</b> (Scissors)	14
<b>Ramsey</b> (Serrated Dissecting Forceps)	16
<b>Ramsey</b> (Toothed Dissecting Forceps)	20
<b>Russian</b> (Toothed Dissecting Forceps)	21
<b>Rutherford Morison</b> (Tissue Forceps)	25
<b>Robin</b> (Towel Clamps)	29
<b>Rampley</b> (Sponge Holding Forceps)	30
<b>Rochester - Oschner</b> (Haemostats Forceps)	36,37
<b>Rochster Pean</b> (Haemostats Forceps)	39
<b>Roberts</b> (Haemostats Forceps)	40
<b>Richardson</b> (Hand Held Retractors)	54
<b>Retractor</b> (Hand Held Retractors)	60
<b>Ricard</b> (Hand Held Retractors)	61
<b>Rntne Hospital</b> (Hand Held Retractors)	63
<b>Recamier</b> (Uterine Cannulae)	85
<b>Randall</b> (Urology)	92
<b>Ruskin</b> (Bone Rongeurs) 1	103
<b>Rudor Edwards Costotome</b> (Bone Rongeurs)	106
<b>Ruskin - Liston</b> (Bone Cutting Forceps)	108
<b>Riches Forceps</b> (Monopolar Cables)	131

### S

<b>Surgical Handles</b> (Standard)	04,05
<b>Strabismus</b> (Delicate Scissors)	11
<b>Stevens Tenotomy</b> (Delicate Scissors)	12
<b>Schuknecht Wire Cutting</b> (Oral Scissors)	12
<b>Schumacher Umbilical</b> (Scissors)	14
<b>St Marks</b> (Serrated Dissecting Forceps)	16
<b>St Marks</b> (Toothed Dissecting Forceps)	21
<b>S.shaped Delicate</b> (Dissecting & Ligature Forceps)	23
<b>Stiles Allis-Thoms</b> (Tissue Forceps)	25
<b>Spencer Wells</b> (Haemostats Forceps)	38
<b>Schmidt Tonsil</b> (Tonsil Artery Forceps)	42
<b>Sinus</b> (Probes)	48
<b>Simon</b> (Hand Held Retractors)	59
<b>Seton Pringle Bainbridge</b> (Intestinal Clamps)	69
<b>Schoemaker</b> (Intestinal Clamps)	70
<b>Sims</b> (Vaginal Speculum)	73
<b>Sims</b> (Probes)	76
<b>Schroeder</b> (Tenaculum Forceps)	78
<b>Schubert</b> (Cervical Biopsy Forceps)	81
<b>Schumarcher</b> (Cervical Biopsy Forceps)	82
<b>Simon</b> (Uterine Scoops And Curettes)	83
<b>Sims</b> (Uterine Scoops And Curettes)	83
<b>Sims</b> (Uterine Curettes)	84
<b>Sims</b> (Uterine Cannulae)	85
<b>Simpson</b> (Obstetrics Instruments)	86
<b>Simpson-Braun</b> (Obstetrics Instruments)	86
<b>Saenger Ovum Forceps</b> (Gynecology Instruments)	88
<b>Sims Rectal Speculum</b> (Proctology)	91
<b>Suction Tubes</b> (Suction Tubes)	95
<b>Spare Disks</b> (Mallets)	100
<b>Sequestum</b> (Bone Holding Forceps)	100
<b>Semb</b> (Bone Holding Forceps)	102
<b>Synovectomy Rongeur</b> (Bone Rongeurs)	104
<b>Sargent Van Havre</b> (Bone Rongeurs)	106

<b>Stille-ruskin</b> (Bone Rongeurs)	106
<b>Stille Liston</b> (Bone Cutting Forceps)	108
<b>Semb</b> (Ligature Carriers)	112
<b>Scalple Handle</b>	132
(Monopolar Handles,Blades,Needle,Turner Warwick Scissors)	

### T

<b>Treves</b> (Delicate Dissecting Forceps)	18
<b>Troeltsch Wilde</b> (Splinter Forceps)	22
<b>Tudichum</b> (Splinter Forceps)	22
<b>Tubing Clamp</b> (Haemostats Forceps)	41
<b>Travers</b> (Hand Held Retractors)	62
<b>Tischler-morgan</b> (Cervical Biopsy Forceps)	82
<b>Tinckler Simpson Smith</b> (Suction Tubes)	94
<b>Trotter</b> (Bone Rongeurs)	104
<b>Treatment Room Items</b> (Treatment Room Items)	139,141

### U

<b>Uterine</b> (Scissors)	09
<b>Umbilical Dilator</b> (Gynecology Instruments)	88

### V

<b>Volkman</b> (Bone Levers & Raspatories)	98
<b>Volkman</b> (Bone Scoops)	99
<b>Verbrugge</b> (Bone Holding Forceps)	102

### W

<b>Woods Tonsil</b> (Oral Scissors)	12
<b>Wheeler Tonsil</b> (Oral Scissors)	12
<b>Wilson Tonsil</b> (Oral Scissors)	12
<b>Waugh</b> (Delicate Dissecting Forceps)	17,18
<b>Wilson Tonsil</b> (Tonsil Artery Forceps)	42
<b>Wangensteen</b> (Needle Holders)	44
<b>Wright</b> (Needle Holders)	45
<b>Ward</b> (Needle Holders)	45
<b>Webster</b> (Needle Holders)	47
<b>Watson Cheyne</b> (Dissectors)	50
<b>Walton</b> (Hand Held Retractors)	58
<b>Weislander</b> (Hand Held Retractors)	63
<b>Weislander</b> (Hand Held Retractors)	63,64
<b>Wilson</b> (Tenaculum Forceps)	78
<b>Wittner</b> (Cervical Biopsy Forceps)	82
<b>Wrigley</b> (Obstetrics Instruments)	86
<b>Winter Ovum Forceps</b> (Gynecology Instruments)	88
<b>Williger</b> (Bone Levers & Raspatories)	97
<b>Wilms</b> (Bone Rongeurs)	104
<b>Ward</b> (Bone Cutting Forceps)	108
<b>Wilson Hey Forceps</b> (Monopolar Cables)	131

### Y

<b>Yankauer</b> (Suction Tubes)	94
---------------------------------	----

### Z

<b>Zaufal-Jansen</b> (Bone Rongeurs)	105
--------------------------------------	-----



Diagnostic  
Laryngoscope  
Scissors  
Dissecting  
Hamostats Forceps  
Needle Holders  
Retractors  
Cordio Vascular  
Electro Surgical  
Hollow Ware



S.S.Surgimed

World Class Instruments Since 1980

[www.sssurgimed.com](http://www.sssurgimed.com) | [info@sssurgimed.com](mailto:info@sssurgimed.com)

**SURGICAL**  
*INSTRUMENTS*

